

Decomposition of Graphs on Surfaces and a Homotopic Circulation Theorem

A. SCHRIJVER

*Mathematical Centre, Kruislaan 413, 1098 SJ Amsterdam, The Netherlands,
and University of Amsterdam, The Netherlands*

Communicated by the Editors

Received September 30, 1987

We prove the following theorem. Let G be an eulerian graph embedded (without crossings) on a compact orientable surface S . Then the edges of G can be decomposed into cycles C_1, \dots, C_l in such a way that for each closed curve D on S

$$\text{mincr}(G, D) = \sum_{i=1}^l \text{mincr}(C_i, D).$$

Here $\text{mincr}(G, D)$ denotes the minimum number of crossings of G and \tilde{D} , among all closed curves \tilde{D} homotopic to D (such that \tilde{D} does not intersect vertices of G). Similarly, $\text{mincr}(C, D)$ denotes the minimum number of crossings of \tilde{C} and \tilde{D} , among all closed curves \tilde{C} and \tilde{D} homotopic to C and D , respectively. As a corollary we derive the following "homotopic circulation theorem." Let $G = (V, E)$ be a graph embedded on a compact orientable surface S , let $c: E \rightarrow \mathbb{Q}_+$ be a "capacity" function, let C_1, \dots, C_k be cycles in G , and let $d_1, \dots, d_k \in \mathbb{Q}_+$ be "demands." Then there exist circulations x_1, \dots, x_k in G such that each x_i decomposes fractionally into d_i cycles homotopic to C_i ($i = 1, \dots, k$) and such that the total flow through any edge does not exceed its capacity, if and only if for each closed curve D on S which does not intersect vertices of G we have that the sum of the capacities of the edges intersected by D (counting multiplicities) is not smaller than $\sum_{i=1}^k d_i \cdot \text{mincr}(C_i, D)$. This applies to a problem posed by K. Mehlhorn in relation to the automatic design of integrated circuits. © 1991 Academic Press, Inc.

1. SURVEY OF RESULTS

In this paper we prove a number of theorems on the decomposition into cycles of the edges of graphs embedded on a compact orientable surface S . (A compact orientable surface is a two-dimensional sphere with a finite number of 'handles' added.) As a main application we give a characterization of the existence of a circulation of a prescribed homotopy type in such graphs. The proof methods used are based on analyzing curves on surfaces and their crossings, and on some classical results in topology (due to

Poincaré, Baer, von Kerékjártó, Brouwer) and linear algebra (Farkas' lemma).

The following result plays a crucial role.

THEOREM 1. *Let G be an eulerian graph embedded on a compact orientable surface S . Then the edges of G can be decomposed into cycles C_1, \dots, C_l in such a way that for each closed curve D on S ,*

$$\text{mincr}(G, D) = \sum_{i=1}^l \text{mincr}(C_i, D). \quad (1)$$

Here and in the sequel we use the following conventions and notation. The graph G has a finite number of vertices and edges, while loops and multiple edges are allowed. A graph is *eulerian* if all its degrees are even (where a loop at vertex v counts for two in the degree of v)—so connectedness is not required. *Embedding* a graph means embedding without intersecting edges. We identified an embedded graph with its image.

A *cycle* in G is a sequence

$$(v_0, e_1, v_1, e_2, v_2, \dots, e_l, v_l), \quad (2)$$

where v_0, \dots, v_l are vertices, with $v_0 = v_l$, and where e_i is an edge connecting v_{i-1} and v_i ($i = 1, \dots, l$). (If e_i is a loop, then we assume that an orientation of e_i is also specified.) *Decomposing the edges into cycles* C_1, \dots, C_l means that each edge occurs in exactly one of the C_i , while in each C_i all edges are different.

A *closed curve* on S is a continuous function $D: S_1 \rightarrow S$, where S_1 denotes the unit circle $\{z \in \mathbb{C} \mid |z| = 1\}$ in the complex plane. So each cycle (2) in G gives rise to a closed curve on S , which curve we identify with the cycle. Two closed curves D and D' on S are called *homotopic* (on S), denoted by $D \sim D'$, if there exists a continuous function $\Phi: S_1 \times [0, 1] \rightarrow S$ such that $\Phi(z, 0) = D(z)$ and $\Phi(z, 1) = D'(z)$ for all $z \in S_1$. (This is sometimes called *freely homotopic* as we do not fix a 'base point'.)

We denote, if D is a closed curve on S not intersecting V ,

$$\begin{aligned} \text{cr}(G, D) &:= |\{z \in S_1 \mid D(z) \text{ belongs to } G\}|, \\ \text{mincr}(G, D) &:= \min\{\text{cr}(G, \tilde{D}) \mid \tilde{D} \sim D, \tilde{D} \text{ does not intersect } V\}. \end{aligned} \quad (3)$$

Moreover, if C and D are closed curves on S ,

$$\begin{aligned} \text{cr}(C, D) &:= |\{y, z \in S_1 \times S_1 \mid C(y) = D(z)\}|, \\ \text{mincr}(C, D) &:= \min\{\text{cr}(\tilde{C}, \tilde{D}) \mid \tilde{C} \sim C, \tilde{D} \sim D\}. \end{aligned} \quad (4)$$

As is well-known, $\text{mincr}(C, D)$ is finite.

Note that the inequality \geq in (1) is trivial, and holds for any decomposition of the edges of G into cycles. The essence of the theorem is that there exists a decomposition which has equality in (1).

Note 1. We do not know if the orientability condition for S in Theorem 1 is necessary. In fact, the theorem is true also if we take for S the projective plane, which result is equivalent to a theorem of Lins [11].

Our proof below also works for nonorientable compact surfaces, if we restrict D in Theorem 1 to ‘orientable’ closed curves, i.e., to those closed curves for which left and right do not flip when one orbit is made (these are the curves which generate an orientable covering surface, in the sense of Section 2).

By means of the duality relation between graphs embedded on a surface we derive from Theorem 1:

THEOREM 2. *Let $G = (V, E)$ be a bipartite graph embedded on a compact orientable surface S , and let C_1, \dots, C_k be cycles in G . Then there exist closed curves $D_1, \dots, D_t: S_1 \rightarrow S$ such that (i) no D_j intersects V , (ii) each edge of G is crossed by exactly one D_j , and only once by this D_j , and (iii) for each $i = 1, \dots, k$,*

$$\text{minlength}_G(C_i) = \sum_{j=1}^t \text{mincr}(C_i, D_j). \tag{5}$$

Here we denote for any cycle C in G

$$\begin{aligned} \text{length}_G(C) &:= l, \text{ if } C = (v_0, e_1, v_1, \dots, e_l, v_l), \\ \text{minlength}_G(C) &:= \min \{ \text{length}_G(\tilde{C}) \mid \tilde{C} \sim C, \tilde{C} \text{ cycle in } G \}. \end{aligned} \tag{6}$$

(Cycles C and \tilde{C} are allowed to traverse one edge several times.)

Note 2. In fact, if G is a bipartite graph embedded on the compact orientable surface S so that each face (=component of $S \setminus G$) is simply connected, then there exist closed curves D_1, \dots, D_t satisfying (i) and (ii) of Theorem 2 such that $\text{minlength}_G(C) = \sum_{j=1}^t \text{mincr}(C, D_j)$ for all cycles C in G .

It is not difficult to see that this implies that if G is a bipartite graph embedded on the torus S , then also the above conclusion holds (as either each face is simply connected, or there is essentially only one cycle C in G to consider)—cf. [6].

This is not true for surfaces with more handles (so in general one must specify an arbitrary, but finite, number of cycles C_i in G in advance)—see the Remark in Section 6.

In [6] it is also shown that if S is the torus, $k = 1$, and $C := C_1$ is homotopic to a simple (i.e., not self-intersecting) closed curve, then we can

delete the bipartiteness condition in Theorem 2. This result is equivalent to the following: let $G = (V, E)$ be a graph embedded on the torus S , and let C be a simple closed curve on S . Then

$$\text{minlength}_G(C) = \max \sum_{j=1}^l \text{mincr}(C, D_j), \quad (7)$$

where the maximum ranges over all collections of closed curves D_1, \dots, D_l on S not intersecting V and intersecting each edge of G at most once.

In terms of integer linear programming, this is equivalent to the 'total dual integrality' of the following system of linear inequalities in the variable $x \in \mathbb{R}^E$ (using the notation of (10) below):

$$\begin{aligned} \text{(i)} \quad & x_e \geq 0 && (e \in E) \\ \text{(ii)} \quad & \sum_{e \in E} \chi^D(e) x_e \geq \text{mincr}(C, D) && (D \text{ closed curve on } S \setminus V). \end{aligned} \quad (8)$$

(Total dual integrality means that any linear program over (8) with integral objective function has integral primal and dual optimum solutions (cf. [19]). It can be shown that (8) can be restricted to only a finite number of inequalities.)

By means of the polarity relation between convex cones in euclidean space (i.e., Farkas' lemma), we deduce from Theorem 2 the following "homotopic circulation theorem," where we use notation as follows. Let $G = (V, E)$ be embedded on a surface S . Let $C = (v_0, e_1, v_1, \dots, e_l, v_l)$ be a cycle in G . Let the function $\chi^C: E \rightarrow \mathbb{Z}_+$ be defined by

$$\chi^C(e) = |\{j = 1, \dots, l \mid e = e_j\}| \quad \text{for } e \in E. \quad (9)$$

Let $D: S_1 \rightarrow S$ be a closed curve on S , not intersecting V , and with $\text{cr}(G, D)$ finite. Let the function $\chi^D: E \rightarrow \mathbb{Z}_+$ be defined by

$$\chi^D(e) := |\{z \in S_1 \mid D(z) \text{ belongs to } e\}| \quad \text{for } e \in E. \quad (10)$$

THEOREM 3. *Let $G = (V, E)$ be a graph embedded on a compact orientable surface S , and let $c: E \rightarrow \mathbb{Q}_+$ ("capacity function"). Let C_1, \dots, C_k be cycles in G , pairwise not homotopic, and let $d_1, \dots, d_k \in \mathbb{Q}_+$ ("demands"). Then there exist cycles $\Gamma_1, \dots, \Gamma_u$ in G and $\lambda_1, \dots, \lambda_u \geq 0$ such that*

$$\begin{aligned} \text{(i)} \quad & \sum_{\substack{j=1 \\ \Gamma_j \sim C_i}}^u \lambda_j = d_i && (i = 1, \dots, k), \\ \text{(ii)} \quad & \sum_{j=1}^u \lambda_j \cdot \chi^{\Gamma_j}(e) \leq c(e) && (e \in E), \end{aligned} \quad (11)$$

if and only if for each closed curve D on S not intersecting V we have

$$\sum_{i=1}^k d_i \cdot \text{mincr}(C_i, D) \leq \sum_{e \in E} c(e) \cdot \chi^D(e). \tag{12}$$

Note 3. In [6, 20] it is shown that if each C_i is homotopic to a simple closed curve, all capacities and demands are integers, and *at least two* of the following conditions hold:

- (i) S is the torus;
- (ii) $k = 1$; (13)
- (iii) the two sides in (12) have the same parity, for each D ;

then we can take the λ_i in Theorem 3 integral. This implies that if each C_i is homotopic to a simple closed curve, all capacities and demands are integers, and (13) (i) or (ii) holds, then we can take the λ_i to be half-integral.

If S is the torus and $k = 1$, this is equivalent to the following min-max result. Let $G = (V, E)$ be a graph embedded on the torus S , and let C be a simple closed curve on S . Then the maximum number of pairwise edge-disjoint cycles in G , each homotopic to C , is equal to the minimum value of

$$\min_D \left\lfloor \frac{\text{cr}(G, D)}{\text{mincr}(C, D)} \right\rfloor, \tag{14}$$

where the minimum ranges over all closed curves D on $S \setminus V$ with $\text{mincr}(C, D) \geq 1$. ($\lfloor \cdot \rfloor$ denotes the lower integer part.) In other words, system (8) has the “integer decomposition property”—cf. [19].

In the Remark in Section 7 we give an example showing that (13)(iii) is not enough to imply integrality of the λ_i , for a general compact orientable surface S . Yet the following min-max *almost*-equality can be shown (cf. [20]). Let $G = (V, E)$ be a graph embedded on a compact orientable surface S , and let C be a simple closed curve on S . Then the maximum number M of pairwise edge-disjoint cycles in G , each homotopic to C , satisfies

$$\min_D \left\lceil \frac{\text{cr}(G, D)}{\text{mincr}(C, D)} \right\rceil - 1 \leq M \leq \min_D \left\lfloor \frac{\text{cr}(G, D)}{\text{mincr}(C, D)} \right\rfloor, \tag{15}$$

where the minima range over all closed curves D on $S \setminus V$ with $\text{mincr}(C, D) \geq 1$. ($\lceil \cdot \rceil$ denotes upper integer part.)

As a consequence of Theorem 3 we derive a “homotopic flow-cut theorem.”

THEOREM 4. *Let $G = (V, E)$ be a planar graph embedded in the complex plane \mathbb{C} . Let I_1, \dots, I_p be (the interiors of) some of the faces of G , including the unbounded face. Let P_1, \dots, P_k be paths in G with end points on the boundary of $I_1 \cup \dots \cup I_p$. Then there exist paths $P_{11}, \dots, P_{1t_1}, P_{21}, \dots, P_{2t_2}, \dots, P_{k1}, \dots, P_{kt_k}$ in G and rationals $\lambda_{11}, \dots, \lambda_{1t_1}, \lambda_{21}, \dots, \lambda_{2t_2}, \dots, \lambda_{k1}, \dots, \lambda_{kt_k} \geq 0$ such that*

$$\begin{aligned}
 \text{(i)} \quad & P_{ij} \sim P_i \text{ in } \mathbb{C} \setminus (I_1 \cup \dots \cup I_p) \quad (i = 1, \dots, k; j = 1, \dots, t_i), \\
 \text{(ii)} \quad & \sum_{j=1}^{t_i} \lambda_{ij} = 1 \quad (i = 1, \dots, k), \\
 \text{(iii)} \quad & \sum_{i=1}^k \sum_{j=1}^{t_i} \lambda_{ij} \chi^{P_{ij}}(e) \leq 1 \quad (e \in E),
 \end{aligned} \tag{16}$$

if and only if for each path $D: [0, 1] \rightarrow \mathbb{C} \setminus (I_1 \cup \dots \cup I_p)$, connecting two points on the boundary of $I_1 \cup \dots \cup I_p$, not intersecting V , and intersecting G only a finite number of times, we have

$$\sum_{i=1}^k \text{mincr}(P_i, D) \leq \text{cr}(G, D). \tag{17}$$

Here we use similar notation and terminology to before. A *path* in G is a sequence $(v_0, e_1, v_1, e_2, v_2, \dots, e_l, v_l)$ where v_0, \dots, v_l are vertices, and where e_i is an edge connecting v_{i-1} and v_i ($i = 1, \dots, l$). A (*topological*) *path* in a topological space T is a continuous function $D: [0, 1] \rightarrow T$. The points $D(0)$ and $D(1)$ are the *end points* of D . So each path in G gives rise to a topological path on \mathbb{C} , which two paths we identify. Two paths $D, D': [0, 1] \rightarrow T$ are called *homotopic (in T)*, denoted by $D \sim D'$, if there exists a continuous function $\Phi: [0, 1] \times [0, 1] \rightarrow T$ such that $\Phi(x, 0) = D(x)$, $\Phi(x, 1) = D'(x)$, $\Phi(0, x) = D(0)$, $\Phi(1, x) = D(1)$ for all $x \in [0, 1]$. (It follows that $D(0) = D'(0)$ and $D(1) = D'(1)$.) If C and D are paths in $\mathbb{C} \setminus (I_1 \cup \dots \cup I_p)$, then

$$\begin{aligned}
 \text{cr}(C, D) &:= |\{(x, y) \in [0, 1] \times [0, 1] \mid C(x) = D(y)\}|, \\
 \text{mincr}(C, D) &:= \min\{\text{cr}(\tilde{C}, \tilde{D}) \mid \tilde{C} \sim C, \tilde{D} \sim D \text{ in } \mathbb{C} \setminus (I_1 \cup \dots \cup I_p)\}.
 \end{aligned} \tag{18}$$

If $C = (v_0, e_1, v_1, \dots, e_l, v_l)$ is a path in G , then $\chi^C: E \rightarrow \mathbb{Z}_+$ is defined by

$$\chi^C(e) := |\{j = 1, \dots, l \mid e = e_j\}| \quad \text{for } e \in E. \tag{19}$$

If $D: [0, 1] \rightarrow \mathbb{C} \setminus (I_1 \cup \dots \cup I_p)$ is a path not intersecting V and intersecting E only a finite number of times, then $\chi^D: E \rightarrow \mathbb{Z}_+$ is defined by

$$\chi^D(e) := |\{x \in [0, 1] \mid D(x) \text{ belongs to } e\}| \quad \text{for } e \in E. \quad (20)$$

Note 4. It was shown by van Hoesel and Schrijver [8] that if $p = 2$, we can take all λ_{ij} in Corollary 3 equal to $\frac{1}{2}$. More generally, the following was shown:

Let $G = (V, E)$ be a planar graph, embedded in \mathbb{C} . Let O denote the interior of the unbounded face, and let I be the interior of some other fixed face. Let P_1, \dots, P_k be paths in G , each with end points on the boundary of $I \cup O$, so that for each vertex v of G the number

$$\deg(v) + |\{i = 1, \dots, k \mid P_i \text{ begins in } v\}| + |\{i = 1, \dots, k \mid P_i \text{ ends in } v\}| \quad (22)$$

is even. Then there exist pairwise edge-disjoint paths P'_1, \dots, P'_k in G such that P'_i is homotopic to P_i in $\mathbb{C} \setminus (I \cup O)$ for $i = 1, \dots, k$, if and only if for each path $D: [0, 1] \rightarrow \mathbb{C} \setminus (I \cup O)$ connecting two points on the boundary of $I \cup O$, not intersecting V , and intersecting G only a finite number of times, we have

$$\sum_{i=1}^k \text{mincr}(P_i, D) \leq \text{cr}(G, D). \quad (23)$$

Here $\deg(v)$ denotes the degree of v in G . It follows that if (22) is omitted, there is a "half-integral" solution.

This result was conjectured by K. Mehlhorn in relation to the automatic design of integrated circuits (see [9]). It generalizes the Okamura-Seymour theorem [15]. Result (21) cannot be extended to more than two faces (in the sense of Theorem 4), as is shown by the following example

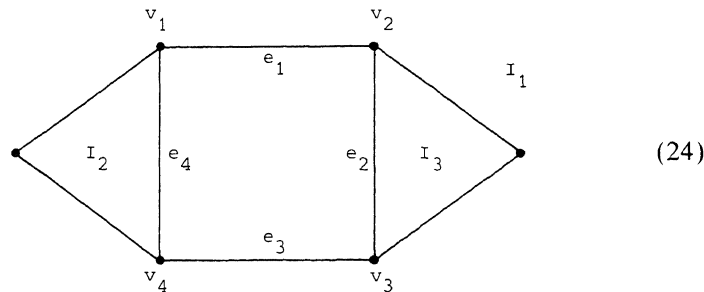

with $P_1 := (v_1, e_1, v_2, e_2, v_3)$ and $P_2 := (v_2, e_2, v_3, e_3, v_4)$. In fact, Theorem 4 answers affirmatively a question asked of me by Professor C.St.J.A. Nash-Williams in Oberwolfach, after a discussion of (21) and (24).

Integrality results for graphs obtained from the planar rectangular grid were obtained by Kaufmann and Mehlhorn [9]. An extension, derived with the help of Theorem 4, to "straight-line" planar graphs is given in [21].

The Main Lemma and Theorem 5: The Relation between Tight Graphs and Minimally Crossing Collections of Curves

As mentioned, we derive Theorem 4 from Theorem 3, Theorem 3 from Theorem 2, and Theorem 2 from Theorem 1. Theorem 1 itself is derived from a "Main Lemma." The content of this Main Lemma is the "only if" part in our fifth theorem, whose "if" part is derived from Theorem 3 (and hence from the Main Lemma).

To formulate Theorem 5, we must introduce some terminology. Let $G = (V, E)$ be an eulerian graph embedded on the compact orientable surface S . Consider a vertex v of G of degree at least 4, and a neighbourhood $N \simeq \mathbb{C}$ of v :

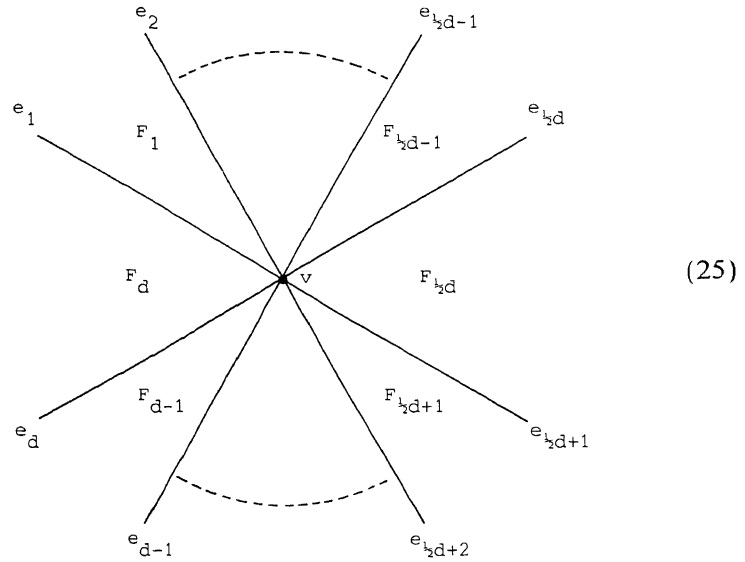

Choose two faces which are opposite in v , say $F_{(1/2)d}$ and F_d (d being the degree of v). Now let G' be the graph obtained by replacing (25) in N by

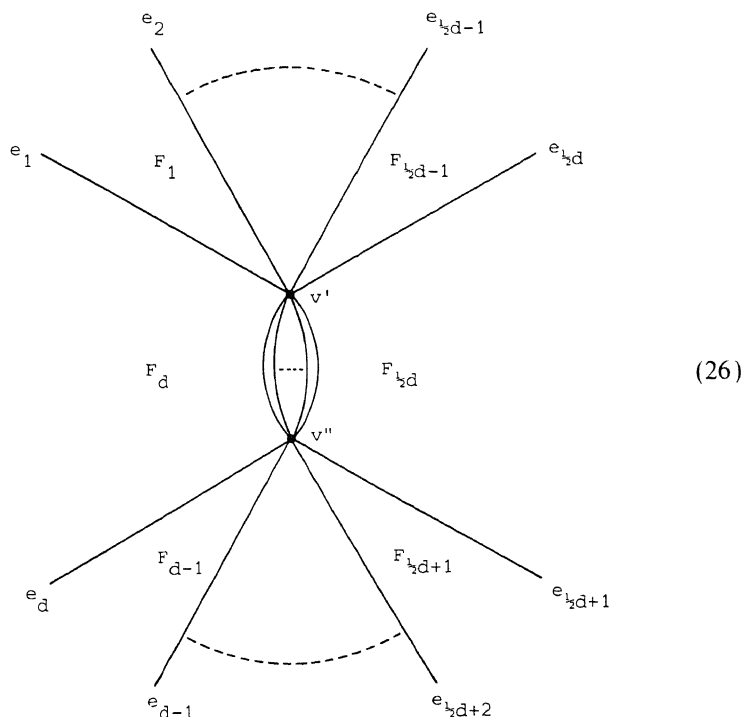

where there are $\frac{1}{2}d - 2$ parallel edges connecting the new vertices v' and v'' . We say that *the connectivity is preserved by opening v from $F_{(1/2)d}$ to F_d* if $\text{mincr}(G', D) = \text{mincr}(G, D)$ for each closed curve D on S . We say that G is *tight* if

- (i) for *no* choice of vertex v and faces F', F'' opposite in v is the connectivity preserved by opening v from F' to F'' ; (27)
- (ii) no component of G is a null-homotopic circuit.

The *straight decomposition* of G is the decomposition of the edges of G into cycles as follows. In each vertex v of G we ‘match’ opposite edges. Thus in (25), edge e_1 is matched to $e_{(1/2)d+1}$, e_2 to $e_{(1/2)d+2}$, ..., $e_{(1/2)d}$ to e_d . This gives us a unique decomposition of the edges of G into cycles,

$$(v_0, e_1, v_1, \dots, e_l, v_l), \tag{28}$$

such that for each $i = 1, \dots, l$, the edges e_i and e_{i+1} are matched in v_i (taking $e_{l+1} := e_1$). This decomposition is unique up to the choice of beginning (=end) point of the cycles and up to the direction of the cycles.

A closed curve $C: S_1 \rightarrow S$ is called *primitive* if C is not homotopic to D^n for some closed curve D and some $n \geq 2$ (where D^n is the closed curve with $D^n(z) := D(z^n)$ for $z \in S_1$). In particular, if C is primitive, C is not null-homotopic.

A collection of closed curves C_1, \dots, C_k is called *minimally crossing* if

$$\begin{aligned} \text{(i)} \quad \text{cr}(C_i, C_j) &= \text{mincr}(C_i, C_j), & \text{for } i, j = 1, \dots, k; i \neq j; \\ \text{(ii)} \quad \text{cr}(C_i) &= \text{mincr}(C_i) & \text{for } i = 1, \dots, k. \end{aligned} \quad (29)$$

Here

$$\begin{aligned} \text{cr}(C) &:= \frac{1}{2} |\{(y, z) \in S_1 \times S_1 \mid C(y) = C(z), y \neq z\}|, \\ \text{mincr}(C) &:= \min\{\text{cr}(\tilde{C}) \mid \tilde{C} \sim C\}. \end{aligned} \quad (30)$$

Now finally we can formulate:

THEOREM 5. *Let G be an eulerian graph embedded on a compact orientable surface S . Then G is tight if and only if the straight decomposition of G forms a minimally crossing collection of primitive closed curves.*

We first give in Section 2 a brief review of the topology of surfaces, and in Section 3 we study closed curves and their crossings. In Section 4 we prove the “Main Lemma”, after which we prove Theorems 1–5 in Sections 5–9. Finally, in Section 10, we derive some further results on curves on surfaces.

We mention that applications of the theorems above can be found in [6, 21–23]. The *vertex-disjoint* case is considered in [24].

3. SURFACES AND COVERING SURFACES

In this paper we will assume some familiarity with the theory of surfaces. This theory belongs to the most basic and classical parts of topology, due to Poincaré, Dehn, Heegaard, Brouwer, Brahana, von Kerékjártó, Radó, and Baer. We will list in this section the results we will use. For extended discussions we refer to the books by Ahlfors and Sario [1], von Kerékjártó [10], Massey [13], Moise [14], and Seifert and Threlfall [25].

A *surface* is an arc-connected Hausdorff space S in which each point x has a neighbourhood N_x homeomorphic to the complex plane \mathbb{C} . S is *orientable* if each N_x can be oriented so that if two N_x and N_y intersect, then their orientations coincide on the intersection.

Each compact orientable surface is homeomorphic to the space obtained from the 2-dimensional sphere by adding some finite number of “handles”

(possibly none) (see Dehn and Heegaard [5, pp. 197–198] and Brahana [3]). Each compact orientable surface S has a *triangulation*, i.e., there exists a graph \mathcal{A} embedded on S so that each face (=component of $S \setminus \mathcal{A}$) is homeomorphic to \mathbb{C} , and is bounded by a triangle of \mathcal{A} . In fact, any graph G embedded on S can be extended to a triangulation (possibly adding new vertices on edges; see Radó [17]). (We use triangulations only in the proofs of Propositions 7 and 9 and Theorem 4.)

We now first settle some notation and terminology for curves, paths, and homotopy. A *closed curve* on a surface S is a continuous function $D: S_1 \rightarrow S$, where $S_1 := \{z \in \mathbb{C} \mid |z| = 1\}$. An *open curve* on S is a continuous function $D: \mathbb{R} \rightarrow S$. A *path* on S is a continuous function $D: [0, 1] \rightarrow S$. The path is said to *go from* $D(0)$ *to* $D(1)$, which two points are called the *end points* of D .

If $D: S_1 \rightarrow S$ is a closed curve on S , then by *path* $D: [0, 1] \rightarrow S$ we denote the path with

$$\text{path}D(x) := D(e^{2\pi i x}) \quad \text{for } x \in [0, 1]. \tag{31}$$

If $D_1, D_2: S_1 \rightarrow S$ are closed curves with $D_1(1) = D_2(1)$, then $D_1 \cdot D_2$ is the closed curve with $(D_1 \cdot D_2)(z) := D_1(z^2)$ if $\text{Im } z \geq 0$, and $:= D_2(z^2)$ if $\text{Im } z < 0$. Similarly, $D_1 \cdots D_n$ is defined. For $n \in \mathbb{Z}$, if $D: S_1 \rightarrow S$ is a closed curve, then D^n is the closed curve with $D^n(z) := D(z^n)$ for $z \in S_1$.

Similarly, if $D_1, D_2: [0, 1] \rightarrow S$ are paths with $D_1(1) = D_2(0)$, then $D_1 \cdot D_2$ is the path with $(D_1 \cdot D_2)(x) := D_1(2x)$ if $0 \leq x \leq \frac{1}{2}$ and $:= D_2(2x - 1)$ if $\frac{1}{2} < x \leq 1$.

Two closed curves $D, \tilde{D}: S_1 \rightarrow S$ are said to be (*freely*) *homotopic*, denoted by $D \sim \tilde{D}$, if there exists a continuous function $\Phi: S_1 \times [0, 1] \rightarrow S$ such that $\Phi(z, 0) = D(z)$ and $\Phi(z, 1) = \tilde{D}(z)$ for all $z \in S_1$. (We say that Φ *transforms* D to \tilde{D} .) This defines an equivalence relation between closed curves; the class containing closed curve D is denoted by $\text{hom}(D)$. D is called *null-homotopic* if D is homotopic to some constant function.

Similarly, two paths $D, \tilde{D}: [0, 1] \rightarrow S$ are said to be *homotopic*, denoted by $D \sim \tilde{D}$, if there exists a continuous function $\Phi: [0, 1] \times [0, 1] \rightarrow S$ such that $\Phi(x, 0) = D(x)$, $\Phi(x, 1) = \tilde{D}(x)$, $\Phi(0, x) = D(0)$, $\Phi(1, x) = D(1)$ for all $x \in [0, 1]$. (We say that Φ *transforms* D to \tilde{D} .) It follows that $D(0) = \tilde{D}(0)$ and $D(1) = \tilde{D}(1)$. Again, homotopy of paths defines an equivalence relation; the class containing path D is denoted by $\text{hom}(D)$. Moreover, for $p, q \in S$,

$$\text{Hom}(p, q) := \{\text{hom}(D) \mid D \text{ is a path from } p \text{ to } q\}. \tag{32}$$

If $p, q, r \in S$ and $\lambda \in \text{Hom}(p, q)$ and $\mu \in \text{Hom}(q, r)$, then $\lambda \cdot \mu := \text{hom}(P \cdot Q)$ for some arbitrary $P \in \lambda$ and $Q \in \mu$ ($\text{hom}(P \cdot Q)$ is easily seen to be independent of the choice of $P \in \lambda$, $Q \in \mu$). This operation makes $\text{Hom}(p, p)$ a

group, the *fundamental group* $\pi_1(S)$ of S (as a group, it is independent of p). A path is called *null-homotopic* if it is homotopic to a constant function.

The Universal Covering Surface

Two 'covering surfaces' play an important role in our proof. The first one is as follows. Choose $p \in S$. The *universal covering surface* S' of S (with respect to p) is the space with point set the set of all homotopy classes of paths starting in p ,

$$\bigcup_{q \in S} \text{Hom}(p, q). \quad (33)$$

A subset T of S' is open if and only if for each $\lambda \in T$, say $\lambda \in \text{Hom}(p, q)$, there exists a neighbourhood N of q in S such that $N \simeq \mathbb{C}$ and such that for each r in N and for each path P in N from q to r the class $\lambda \cdot \text{hom}(P)$ belongs to T .

Now Poincaré [16] showed:

PROPOSITION 1. *If S is a compact orientable surface, with at least one handle, then the universal covering surface S' of S is homeomorphic to \mathbb{C} .*

The *projection* $\rho: S' \rightarrow S$ is the continuous function defined by $\rho(\lambda) := q$ if $\lambda \in \text{Hom}(p, q)$. For any closed curve $D: S_1 \rightarrow S$ with $D(1) = q$, say, and for any $\lambda \in \text{Hom}(p, q)$, there is a unique continuous function $D': \mathbb{R} \rightarrow S'$ such that $D'(0) = \lambda$ and $(\rho \circ D')(x) = D(e^{2\pi i x})$ for all $x \in \mathbb{R}$. D' is called the *lifting of D to S' by λ* . It can be described explicitly by

$$D'(x) = \lambda \cdot \text{hom}(D(e^{2\pi i xy})_{y \in [0,1]}) \quad \text{for } x \in \mathbb{R}. \quad (34)$$

(We use the notation $f(y)_{y \in I}$ for a function f on I .)

Similarly, for any path $D: [0, 1] \rightarrow S$ with $D(0) = q$, say, and for any $\lambda \in \text{Hom}(p, q)$, the unique path $D': [0, 1] \rightarrow S'$ satisfying $D'(0) = \lambda$ and $\rho \circ D' = D$ is called the *lifting of D to S' by λ* . It satisfies

$$D'(x) = \lambda \cdot \text{hom}(D(xy)_{y \in [0,1]}) \quad \text{for } x \in [0, 1]. \quad (35)$$

Note the symmetry of the universal covering surface: the universal covering surface and the liftings are essentially independent of the choice of the point p . If S' and \tilde{S}' are the universal covering surfaces of S with respect to the points p and \tilde{p} , respectively, and if $\mu \in \text{Hom}(\tilde{p}, p)$, then $F_\mu: S' \rightarrow \tilde{S}'$ defined by $F_\mu(\lambda) := \mu \cdot \lambda$ is a homeomorphism. Moreover, if $D: S_1 \rightarrow S$ is a closed curve, with $q := D(1)$, if $\lambda \in \text{Hom}(p, q)$, $\tilde{\lambda} \in \text{Hom}(\tilde{p}, q)$, and if D' and \tilde{D}' denote the liftings of D to S' and \tilde{S}' , respectively, by λ and $\tilde{\lambda}$, respectively, then $\tilde{D}' = F_{(\tilde{\lambda} \cdot \lambda^{-1})} \circ D'$.

The Covering Surface Generated by a Closed Curve

The other “covering surface” we will use arises by “rolling up” the universal covering surface S' along a curve. Let $D: S_1 \rightarrow S$ be a closed curve, and let $p := D(1)$. The covering surface S'' generated by D is the quotient space of the universal covering space S' with respect to p , obtained by identifying $\lambda \in S'$ and $\mu \in S'$ iff $\lambda = \text{hom}(\text{path}(D^n)) \cdot \mu$ for some $n \in \mathbb{Z}$. So any point of S'' can be described by $\langle \lambda \rangle$, where $\lambda \in S'$ and where $\langle \lambda \rangle$ denotes the class of λ under the equivalence just defined.

Let $\psi: S' \rightarrow S''$ denote the quotient map. So $\psi(\lambda) = \langle \lambda \rangle$. The projection $\rho': S'' \rightarrow S$ is the function given by $\rho'(\langle \lambda \rangle) := q$ if $\lambda \in \text{Hom}(p, q)$. So $\rho' \circ \psi = \rho$.

There is a unique closed curve $D'': S_1 \rightarrow S''$ so that $D''(1) = \langle \mathbf{1} \rangle$ (where $\mathbf{1}$ is the unit element in $\text{Hom}(p, p)$) and $\rho' \circ D'' = D$. It can be specified by

$$D''(z) = \langle \text{hom}(D(e^{2\pi i x}),_{y \in [0,1]}) \rangle \quad \text{for } z \in S_1, \quad (36)$$

where x is so that $z = e^{2\pi i x}$. (Note that (36) is invariant under replacement of x by $x + 1$.) We call D'' the lifting of D to S'' . We show

PROPOSITION 2. *Let S be a compact orientable surface, and let $D: S_1 \rightarrow S$ be a non-null-homotopic, closed curve. Then the covering surface S'' generated by D is homeomorphic to $\mathbb{C} \setminus \{0\}$, in such a way that the lifting D'' of D to S'' is homotopic to the unit circle in \mathbb{C} .*

(The unit circle here is the identical function $S_1 \rightarrow S_1$.)

Proof. I. We first show that the fundamental group $\pi_1(S'')$ of S'' is isomorphic to the infinite cyclic group \mathbb{Z} . Let $p'' := \langle \mathbf{1} \rangle \in S''$, where $\mathbf{1}$ denotes the unit element in $\text{Hom}(p, p)$. So $\pi_1(S'') \cong \text{Hom}(p'', p'')$. Now $\text{path } D''$ is a path from p'' to p'' . Moreover, $\text{path } D''$ is not null-homotopic, since D is not null-homotopic (if $\Phi: [0, 1] \times [0, 1] \rightarrow S''$ would transform $\text{path } D''$ to a constant function, then $\rho' \circ \Phi$ transforms $\rho' \circ \text{path } D'' = \text{path } D$ to a constant function).

We next show that any path $P: [0, 1] \rightarrow S''$ from p'' to p'' is homotopic to $(\text{path } D'')^n$ for some $n \in \mathbb{Z}$. Indeed, $\rho' \circ P: [0, 1] \rightarrow S$ is a path from p to p . Let Q be the lifting of $\rho' \circ P$ to S' by $\mathbf{1}$. Then $\rho' \circ (\psi \circ Q) = \rho' \circ P$ and hence $\psi \circ Q = P$ (by elementary topology—see Massey [13, Ch. 5, Lemma 3.1]). In particular, $(\psi \circ Q)(1) = P(1)$, implying that $\langle \text{hom}(\rho' \circ P) \rangle = \langle \mathbf{1} \rangle$. Hence, by definition of $\langle \cdot \rangle$, $\rho' \circ P \sim (\text{path } D)^n = \rho' \circ (\text{path } D'')^n$ for some $n \in \mathbb{Z}$. Therefore, $P \sim (\text{path } D'')^n$ (again by elementary topology—see Massey [13: Ch 5, Lemma 3.3]).

II. Now by von Kerékjártó’s classification theorem [10:5. Abschnitt] (see Richards [18] and Goldman [7] for more modern treatments), any orientable surface with infinite cyclic fundamental group is homeomorphic

to $\mathbb{C} \setminus \{0\}$. By I above, the fundamental group of S'' is generated by $\text{hom}(\text{path } D'')$. So S'' is homeomorphic to $\mathbb{C} \setminus \{0\}$. Clearly, the fundamental group of $\mathbb{C} \setminus \{0\}$ is generated by the unit circle. Hence we may assume D'' to be homotopic to the unit circle. ■

We finally mention the following classical theorem to be used [4]:

BROUWER'S FIXED POINT THEOREM. *Let $K \subseteq \mathbb{C}$ be compact and convex, and let $f: K \rightarrow K$ be continuous. Then $f(z) = z$ for some $z \in K$.*

3. CURVES AND THEIR CROSSINGS

In this section we study, with the help of the covering surfaces treated in Section 2, how often curves on a compact orientable surface must cross. That is, we study the following concepts. If C and D are closed curves, let

$$\begin{aligned} X(C, D) &:= \{(y, z) \in S_1 \times S_1 \mid C(y) = D(z)\}, \\ \text{cr}(C, D) &:= |X(C, D)|, \\ \text{mincr}(C, D) &:= \min\{\text{cr}(\tilde{C}, \tilde{D}) \mid \tilde{C} \sim C, \tilde{D} \sim D\}. \end{aligned} \tag{37}$$

As is well-known, $\text{mincr}(C, D)$ is finite. We also study self-crossings of one closed curve C . Let

$$\begin{aligned} X(C) &:= \{(y, z) \in S_1 \times S_1 \mid C(y) = C(z), y \neq z\}, \\ \text{cr}(C) &:= \frac{1}{2} |X(C)|, \\ \text{mincr}(C) &:= \min\{\text{cr}(\tilde{C}) \mid \tilde{C} \sim C\}. \end{aligned} \tag{38}$$

Note that if $X(C)$ is finite, it has an even number of elements (as $(y, z) \in X(C)$ if and only if $(z, y) \in X(C)$). Note also the difference between $\text{mincr}(C)$ and $\text{mincr}(C, C)$: in the latter we minimize over pairs of curves each homotopic to C . We shall see that the following direct relation holds if C is primitive: $\text{mincr}(C) = \frac{1}{2} \text{mincr}(C, C)$. (Recall that a curve C is *primitive* if there is no closed curve D and $n \geq 2$ so that $C \sim D^n$.)

We now first give two useful auxiliary results. We say that a closed curve $D: S_1 \rightarrow S$ has *no null-homotopic parts* if there exist no $y, z \in \mathbb{R}$ with $0 < |y - z| \leq 1$ so that the path $x \mapsto D(e^{2\pi i((1-x)y + xz)})$ for $x \in [0, 1]$ is a null-homotopic path. In fact, the condition $|y - z| \leq 1$ can be deleted, which is the content of the following proposition.

PROPOSITION 3. *Let S be a compact orientable surface. If the closed curve $D: S_1 \rightarrow S$ has no null-homotopic parts, then any lifting of D to the universal covering surface S' is a one-to-one function.*

Proof. By the symmetry of the universal covering surface, we may assume that S' is the universal covering surface with respect to $p := D(1)$, and that we consider the lifting D' of D to S' by 1 (the unit element of $\text{Hom}(p, p)$). Let S'' be the covering surface generated by D , and let $D'' : S_1 \rightarrow S''$ be the lifting of D to S'' . Since D has no null-homotopic parts, also D'' has no null-homotopic parts (as $D = \rho' \circ D''$). Hence D'' is one-to-one. Proposition 2 then implies that for each $n \in \mathbb{Z} \setminus \{0\}$, the closed curve $(D'')^n$ has no null-homotopic parts. Therefore, D' is one-to-one. ■

Next we show that if the closed curve C is homotopic to D^n for some closed curve D and some $n \geq 2$, then C can be decomposed as the product of a curve $\tilde{D} \sim D$ and a curve $E \sim D^{n-1}$. More precisely:

PROPOSITION 4. *Let C and D be closed curves on a compact orientable surface S and let $n \in \mathbb{N}$ so that $C \sim D^n$. Then there exists an orientation preserving homeomorphism $\varphi : S_1 \rightarrow S_1$ so that the closed curve $C \circ \varphi$ is equal to $\tilde{D} \cdot E$, where $\tilde{D} \sim D$ and $E \sim D^{n-1}$.*

(A homeomorphism $\varphi : S_1 \rightarrow S_1$ is called *orientation preserving* if φ is homotopic to the identity function on S_1 , in the space $\mathbb{C} \setminus \{0\}$.)

Proof. I. Without loss of generality, $n \geq 2$ and D is not null-homotopic. Let S'' be the covering surface generated by D , with projection function $\rho' : S'' \rightarrow S$, and let $D'' : S_1 \rightarrow S''$ be the lifting of D to S'' . As $C \sim D^n$, also C has a closed curve $C'' : S_1 \rightarrow S''$ as a lifting to S'' (i.e., one satisfying $\rho' \circ C'' = C$). We can give C'' by

$$C''(z) = \langle \Phi \circ P \rangle, \tag{39}$$

where $\Phi : S_1 \times [0, 1] \rightarrow S$ is a (fixed) continuous function transforming D'' to C , and where P is an arbitrary path on $S_1 \times [0, 1]$ from $(1, 0)$ to $(z, 1)$. (The fact that (39) is independent of the choice of P follows from the fact that if P and P' are paths on $S_1 \times [0, 1]$ from $(1, 0)$ to $(z, 1)$, then P' is homotopic to $\Delta^k \cdot P$ for some $k \in \mathbb{Z}$, where Δ denotes the path following the boundary $S_1 \times \{0\}$ of $S_1 \times [0, 1]$. Hence

$$\begin{aligned} \Phi \circ P' &\sim \Phi \circ (\Delta^k \cdot P) \\ &= (\Phi \circ \Delta^k) \cdot (\Phi \circ P) \sim (\text{path}(D''))^k \cdot (\Phi \circ P) \sim \text{path}(D^{nk}) \cdot (\Phi \circ P). \end{aligned} \tag{40}$$

Hence $\langle \Phi \circ P' \rangle = \langle \Phi \circ P \rangle$ by definition of $\langle \cdot \rangle$.)

In fact, C'' is homotopic to $(D'')^n$ on S'' (as $(D'')^n$ is transformed to C'' by the function $\Phi'' : S_1 \times [0, 1] \rightarrow S''$ defined by $\Phi''(z, x) := \langle \Phi \circ P \rangle$, where P is any path on $S_1 \times [0, 1]$ from $(1, 0)$ to (z, x)).

Since S'' is homeomorphic to $\mathbb{C} \setminus \{0\}$, in such a way that D'' is homotopic to the unit circle, it now follows by plane topology, which we elaborate in

part II of this proof, that we can “split off” from C'' a cycle going once around the origin (thus homotopic to D''). That is, there exists an orientation preserving homeomorphism $\varphi: S_1 \rightarrow S_1$ such that the closed curve $C'' \circ \varphi$ is equal to $\tilde{D}'' \cdot B$, where $\tilde{D}'' \sim D''$ and $B \sim (D'')^{n-1}$.

This φ has the property required by Proposition 4, since

$$C \circ \varphi = \rho' \circ C'' \circ \varphi = \rho' \circ (\tilde{D}'' \cdot B) = (\rho' \circ D'') \cdot (\rho' \circ B), \quad (41)$$

while $\rho' \circ \tilde{D}'' \sim \rho' \circ D'' = D$ and $\rho' \circ B \sim \rho' \circ (D'')^{n-1} = D^{n-1}$.

II. We now elaborate that from any closed curve $\Gamma: S_1 \rightarrow \mathbb{C} \setminus \{0\}$ which is homotopic to Δ^n , where $\Delta: S_1 \rightarrow \mathbb{C} \setminus \{0\}$ is the identity function, we can “split off” a cycle homotopic to Δ . That means that there exists an orientation preserving homeomorphism $\varphi: S_1 \rightarrow S_1$ such that $\Gamma \circ \varphi = \tilde{\Delta} \cdot E$ with $\tilde{\Delta} \sim \Delta$ and $E \sim \Delta^{n-1}$. We may assume $n \geq 2$.

Without loss of generality, $\min\{|\Gamma(z)| \mid z \in S_1\}$ and $\max\{|\Gamma(z)| \mid z \in S_1\}$ are attained at $z=1$ and $z=-1$, respectively. Let $\alpha := |\Gamma(1)|$ and $\beta := |\Gamma(-1)|$.

Consider \mathbb{C} as the universal covering surface of $\mathbb{C} \setminus \{0\}$, with projection function $\psi: \mathbb{C} \rightarrow \mathbb{C} \setminus \{0\}$ given by $\psi(z) = e^{2\pi z}$. A lifting Γ' of Γ is a continuous function $\Gamma': \mathbb{R} \rightarrow \mathbb{C}$ satisfying $(\psi \circ \Gamma')(x) = \Gamma(e^{2\pi i x})$ for all $x \in \mathbb{R}$.

In fact, as Γ is contained in the closed annulus $\{z \in \mathbb{C} \mid \alpha \leq |z| \leq \beta\}$, we know that any lifting Γ' is contained in the strip $\{z \in \mathbb{C} \mid \log \alpha \leq \operatorname{Re} z \leq \log \beta\}$. Let $\operatorname{bd}_\alpha := \{z \mid \operatorname{Re} z = \log \alpha\}$ and $\operatorname{bd}_\beta := \{z \mid \operatorname{Re} z = \log \beta\}$ be the two borders of this strip. As $|\Gamma(1)| = \alpha$ and $|\Gamma(-1)| = \beta$, we know that $\Gamma'|[0, \frac{1}{2}]$ is a path from bd_α to bd_β , and $\Gamma'|[\frac{1}{2}, 1]$ is a path from bd_β to bd_α . Since Γ is homotopic to Δ^n , any lifting Γ' satisfies $\Gamma'(x+1) = \Gamma'(x) + ni$ for all $x \in \mathbb{R}$.

Now there exist liftings Γ' and Γ'' of Γ to \mathbb{C} such that $\Gamma''(x) = \Gamma'(x) + i$ for all $x \in \mathbb{R}$. Path $\Gamma''|[0, \frac{1}{2}]$ connects $\Gamma''(0)$ on bd_α and $\Gamma''(\frac{1}{2})$ on bd_β , while $\Gamma'|[\frac{1}{2}, 1]$ connects $\Gamma'(\frac{1}{2}) = \Gamma''(\frac{1}{2}) - i$ on bd_β and $\Gamma'(1) = \Gamma''(0) + ni - i$ on bd_α . So these two paths must intersect somewhere, say $\Gamma''(x) = \Gamma'(y)$ with $0 \leq x \leq \frac{1}{2} \leq y \leq 1$.

Then $\Gamma''|[x, y]$ is a path from $\Gamma''(x)$ to $\Gamma''(y) = \Gamma'(y) + i = \Gamma''(x) + i$. So $(\psi \circ \Gamma'')|[x, y]$ forms a closed curve $\tilde{\Delta}$ in $\mathbb{C} \setminus \{0\}$ homotopic to Δ . Moreover, $\Gamma''|[y, x+1]$ is a path from $\Gamma''(y)$ to $\Gamma''(x+1) = \Gamma''(x) + ni = \Gamma'(y) + ni = \Gamma''(y) + ni - i$. So $(\psi \circ \Gamma'')|[y, x+1]$ forms a closed curve E in $\mathbb{C} \setminus \{0\}$ homotopic to Δ^{n-1} . ■

Proposition 4 has the following consequence:

PROPOSITION 5. *If C and D are closed curves on the compact orientable surface S and $n \in \mathbb{N}$, then $\operatorname{mincr}(C, D^n) = n \cdot \operatorname{mincr}(C, D)$.*

Proof. Clearly, $\operatorname{mincr}(C, D^n) \leq n \cdot \operatorname{mincr}(C, D)$, since there exist $\tilde{C} \sim C$

and $\tilde{D} \sim D$ such that $\text{cr}(\tilde{C}, \tilde{D}) = \text{mincr}(C, D)$, whence $\text{mincr}(C, D^n) \leq \text{cr}(\tilde{C}, \tilde{D}^n) = n \cdot \text{cr}(\tilde{C}, \tilde{D}) = n \cdot \text{mincr}(C, D)$.

The reverse inequality is shown by induction on n , the cases $n=0$ and $n=1$ being trivial. Let $n \geq 2$, and let closed curves $\tilde{C} \sim C$ and $B \sim D^n$ be such that $\text{cr}(\tilde{C}, B) = \text{mincr}(C, D^n)$. By proposition 4, we may assume that $B = \tilde{D} \cdot E$ with $\tilde{D} \sim D$ and $E \sim D^{n-1}$. Then we obtain

$$\begin{aligned} \text{mincr}(C, D^n) &= \text{cr}(\tilde{C}, B) = \text{cr}(\tilde{C}, \tilde{D}) + \text{cr}(\tilde{C}, E) \\ &\geq \text{mincr}(C, D) + \text{mincr}(C, D^{n-1}) \\ &\geq \text{mincr}(C, D) + (n-1) \cdot \text{mincr}(C, D) = n \cdot \text{mincr}(C, D). \quad \blacksquare \end{aligned} \tag{42}$$

As before, define a collection C_1, \dots, C_k of closed curves on S to be *minimally crossing* if (i) $\text{cr}(C_i) = \text{mincr}(C_i)$ for $i = 1, \dots, k$; (ii) $\text{cr}(C_i, C_j) = \text{mincr}(C_i, C_j)$ for $i, j = 1, \dots, k$, $i \neq j$. Closely related are the following conditions for closed curves C_1, \dots, C_k on S (where S' denotes the universal covering surface of S):

- (i) for each $i = 1, \dots, k$, any lifting of C_i to S' is a not-self-intersecting curve;
- (ii) for each $i = 1, \dots, k$, any two liftings of C_i to S' either have the same image or intersect each other in at most one point;
- (iii) for each $i, j = 1, \dots, k$ with $i \neq j$, any lifting of C_i to S' has at most one point in common with any lifting of C_j to S' .

We call these conditions the *simplicity conditions*. What we will show below is that a collection of *primitive* curves C_1, \dots, C_k is minimally crossing if and only if it satisfies the simplicity conditions (43).

Let us first mention a basic theorem of Baer [2, Satz 2]:

PROPOSITION 6. *For any collection of closed curves C_1, \dots, C_k on a compact orientable surface S there exist curves $\tilde{C}_1 \sim C_1, \dots, \tilde{C}_k \sim C_k$ such that $\tilde{C}_1, \dots, \tilde{C}_k$ satisfy the simplicity conditions (43).*

For the proof, based on Poincaré's representation of the universal covering surface as a hyperbolic plane, we refer to [2].

Remark. Bear showed moreover that if C_1, \dots, C_k satisfy the simplicity conditions (43), then for any lifting C'_i of any C_i , the set of points on C'_i which are also on a lifting C'_j of any C_j (possibly $j=i$) so that the image of C'_j is different from the image of C'_i does not have any point of accumulation in S' . Equivalently, the curves C_1, \dots, C_k intersect themselves and each other in a finite number of points of S .

We derive from Baer's theorem a formula for $\text{mincr}(C, D)$. To this end, for any closed curve $D: S_1 \rightarrow S$ and $z, z' \in S_1$, let us call a path $P: [0, 1] \rightarrow S$ a z - z' -walk along D if there exist $t, t' \in \mathbb{R}$ such that

$$\begin{aligned} z &= e^{2\pi i t}, & z' &= e^{2\pi i t'} \\ P(x) &= D(e^{2\pi i((1-x)t + xt')}), & \text{for } x &\in [0, 1]. \end{aligned} \quad (44)$$

Now let $C, D: S_1 \rightarrow S$ be closed curves on S such that the set $X(C, D)$ is finite, and such that if $(y, z) \in X(C, D)$ then C and D form crossing curves, if we restrict them to small neighbourhoods of y and z . Define the following equivalence relation on $X(C, D)$:

$$(y, z) \approx (y', z') \text{ iff some } y - y' \text{-walk along } C \text{ is homotopic to some } z - z' \text{-walk along } D. \quad (45)$$

It is not difficult to see that this defines an equivalence relation. We call a class of this relation *odd* if it contains an odd number of elements. Let

$$\text{odd}(C, D) := \text{number of odd classes of } \approx. \quad (46)$$

PROPOSITION 7. $\text{mincr}(C, D) = \text{odd}(C, D)$.

Proof. We use the theory of simplicial approximation (see Seifert and Threlfall [25, Sect. 44]). Let $C_1 \sim C$ and $D_1 \sim D$ attain $\text{mincr}(C, D)$, and let $\tilde{C} \sim C$ and $\tilde{D} \sim D$ be as given by Baer's theorem. We may assume that $C, C_1, \tilde{C}, D, D_1, \tilde{D}$ intersect each other and themselves only a finite number of times (cf. Remark above). Hence we may assume that C, C_1 , and \tilde{C} each follow the edges of a triangulation Γ of S , and that D, D_1 , and \tilde{D} each follow the edges of some other triangulation Δ of S , so that Γ and Δ intersect each other only in (crossing) edges.

Now one easily checks that $\text{odd}(C, D)$ is invariant under the following modification of C : if C passes edge e of triangle T of Γ , replace e by the other two edges of T ; similarly for D with respect to Δ . Since C_1 and D_1 arise from C and D by a series of these modifications and their reverses, we know that

$$\text{mincr}(C, D) = \text{cr}(C_1, D_1) \geq \text{odd}(C_1, D_1) = \text{odd}(C, D). \quad (47)$$

On the other hand, for \tilde{C} and \tilde{D} we have that each class of \approx consists of one element (this is exactly the property described by (43)(iii)), and hence

$$\text{mincr}(C, D) \leq \text{cr}(\tilde{C}, \tilde{D}) = \text{odd}(\tilde{C}, \tilde{D}) = \text{odd}(C, D). \quad \blacksquare \quad (48)$$

A direct consequence is

PROPOSITION 8. *Let S be a compact orientable surface, with universal covering surface S' , and let $C, D: S_1 \rightarrow S$ be closed curves on S . Then $\text{cr}(C, D) = \text{mincr}(C, D)$ if and only if each lifting of C to S' intersects each lifting of D to S' at most once.*

Proof. Since $\text{odd}(C, D) = \text{cr}(C, D)$ if and only if each lifting of C to S' intersects each lifting of D to S' at most once, the result follows directly from Proposition 7. ■

Self-crossings of curves can be treated almost similarly. Let $C: S_1 \rightarrow S$ be a closed curve on the compact orientable surface S , such that $\text{cr}(C)$ is finite and such that if $(y, z) \in X(C)$ then in neighbourhoods of y and z C forms a pair of crossing curves. Define the following equivalence relation on $X(C)$:

$$(y, z) \approx (y', z') \text{ iff some } y\text{-}y'\text{-walk along } C \text{ is} \tag{49}$$

$$\text{homotopic to some } z\text{-}z'\text{-walk along } C.$$

Again it is not difficult to see that this defines an equivalence relation. As $|X(C)|$ is even, we have that the number

$$\text{odd}(C) := \text{the number of odd equivalence classes of } \approx \tag{50}$$

is even. Now

PROPOSITION 9. *If C is primitive, then $\text{mincr}(C) = \frac{1}{2}\text{odd}(C)$.*

Proof. Similar to the proof of Proposition 7. Note that the primitive-ness of C is used in the fact that if $\tilde{C} \sim C$ satisfies (43)(ii), then $X(\tilde{C})$ is finite, implying $\text{cr}(C) = \text{odd}(C)$. ■

Note that the formula in Proposition 9 generally does not hold for non-primitive closed curves. For example, on the torus for each non-primitive closed curve C we have $\text{odd}(C) = 0$ while $\text{mincr}(C) > 0$ (unless C is null-homotopic).

Analogous to Proposition 8 is the following:

PROPOSITION 10. *Let S be a compact orientable surface, with universal covering surface S' , and let $C: S_1 \rightarrow S$ be a closed curve on S . Then the following are equivalent:*

- (i) C is primitive and $\text{cr}(C) = \text{mincr}(C)$;
- (ii) $\text{cr}(C)$ is finite, each lifting of C to S' is a non-self-intersecting curve, and each two liftings of C to S' intersect each other at most once, unless their images coincide. (51)

Proof. By the above, it suffices to show that (ii) implies that C is primitive. Suppose $C \sim D^n$ for some closed curve $D: S_1 \rightarrow S$ and $n \geq 2$. By Proposition 4 there exists an orientation preserving homeomorphism $\varphi: S_1 \rightarrow S_1$ such that $C \circ \varphi = \tilde{D} \cdot E$ for some $\tilde{D} \sim D$ and $E \sim D^{n-1}$. Without loss of generality, φ is the identity function, so that $C \circ \varphi = C$. Let S' be the universal covering surface with respect to $C(1) = C(-1)$. Consider the liftings C' and \tilde{C}' of C to S' by $\mathbf{1}$ and by $\lambda := \text{hom}(\text{path}(D))$, respectively. Let $\mu := \text{hom}(\text{path}(C))$. Then

$$\begin{aligned} C'(\tfrac{1}{2}) &= \lambda = \tilde{C}'(0), \\ C'(\tfrac{3}{2}) &= \lambda \cdot \mu = \tilde{C}'(1). \end{aligned} \tag{52}$$

Hence, by (ii), the images of C' and \tilde{C}' coincide. This implies that $C'(y) = \tilde{C}'(z)$ for infinitely many pairs of distinct values of y, z . Hence $X(C)$ is infinite, contradicting the assumption. ■

The following proposition gives a relation between the two functions mincr we studied in this section.

PROPOSITION 11. *If C is primitive, then $\text{mincr}(C) = \frac{1}{2} \text{mincr}(C, C)$.*

Proof. Let C be such that $\text{cr}(C) = \text{mincr}(C)$. “Draw” a curve \tilde{C} parallel and close “to the right of” C . One easily checks that $\text{cr}(C, \tilde{C}) = 2 \cdot \text{cr}(C)$, and that each lifting of \tilde{C} intersects each lifting of C at most once (if \tilde{C} is close enough to C —“close enough” can be made precise by considering a triangulation of S , and by lifting this triangulation to S'). So by Propositions 8 and 10, $\text{mincr}(C, C) = \text{cr}(C, \tilde{C}) = 2 \cdot \text{cr}(C) = 2 \cdot \text{mincr}(C)$. ■

The above also implies:

PROPOSITION 12. *Let C_1, \dots, C_k be primitive closed curves. Then C_1, \dots, C_k is a minimally crossing collection of curves if and only if C_1, \dots, C_k satisfy the simplicity condition (43).*

Proof. Directly from Propositions 8 and 10. ■

We finally show an important property of minimally crossing collections of primitive closed curves:

PROPOSITION 13. *Let C_1, \dots, C_k be a minimally crossing collection of primitive closed curves on a compact orientable surface S . Then for any closed curve D on S there exists a closed curve $\tilde{D} \sim D$ such that $\text{cr}(C_i, \tilde{D}) = \text{mincr}(C_i, D)$ for every $i = 1, \dots, k$.*

(In fact it can be shown that if D is primitive, we can take \tilde{D} so that moreover $\text{cr}(\tilde{D}) = \text{mincr}(D)$.)

Proof. Choose $\tilde{D} \sim D$ so that

$$\sum_{i=1}^k \text{cr}(C_i, \tilde{D}) \tag{53}$$

is as small as possible. We may assume that $\tilde{D} = D$. We now first show that for each $n \in \mathbb{N}$ and $E \sim D^n$,

$$\sum_{i=1}^k \text{cr}(C_i, E) \geq n \cdot \sum_{i=1}^k \text{cr}(C_i, D). \tag{54}$$

This is shown by induction on n , the case $n=0$ being trivial. If $n \geq 1$, by Proposition 4 we know that we may assume that $E = D' \cdot B$ with $D' \sim D$ and $B \sim D^{n-1}$. This implies

$$\begin{aligned} \sum_{i=1}^k \text{cr}(C_i, E) &= \sum_{i=1}^k \text{cr}(C_i, D') + \sum_{i=1}^k \text{cr}(C_i, B) \\ &\geq \sum_{i=1}^k \text{cr}(C_i, D) + (n-1) \cdot \sum_{i=1}^k \text{cr}(C_i, D) \\ &= n \cdot \sum_{i=1}^k \text{cr}(C_i, D), \end{aligned} \tag{55}$$

using the minimality of (53). This proves (54).

As we may assume that D has no null-homotopic parts, by Proposition 3 we know that any lifting of D to the universal covering surface S' of S is a non-self-intersecting curve.

We show that $\text{cr}(C_i, D) = \text{mincr}(C_i, D)$ for all $i = 1, \dots, k$. Suppose this does not hold. Then by Proposition 8, there exists a lifting C'_i of some C_i to S' which has more than one intersection with some lifting D' of D to S' . Without loss of generality, $i = 1$. Then part of D' makes with part of C'_1 the configuration in S'

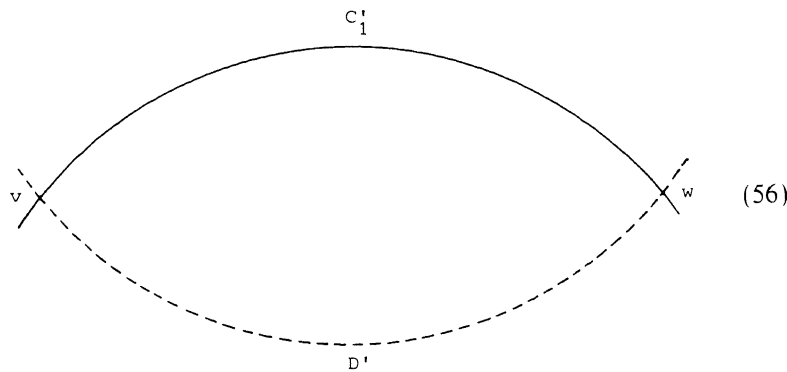

where the uninterrupted curve is part of C_1 and the interrupted curve is part of D' , and where these curve-parts have no intersections except at v and w .

For each $x \in \mathbb{R}$, the restriction $D'|[x, x+1)$ of D' corresponds to one turn of cycle D . The number (53) is equal to the number of times $D'|[x, x+1)$ intersects any lifting of any C_i . Let x and y be such that $D'(x) = v$ and $D'(y) = w$ (cf. (56)). Without loss of generality, $0 < x < y$. Choose $n \in \mathbb{N}$ so that $y < n$. Note that the image of D' is also the image of a lifting of D^n to S' . We can divert the image of D' , and hence also D^n (through the projection function $\pi: S' \rightarrow S$), along the outer side of the v - w -part of C_1 :

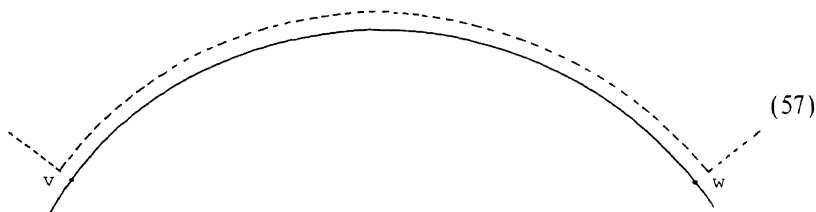

Let this give curve $E \sim D^n$. Since the simplicity conditions (43) hold for C_1, \dots, C_k we know that this diversion decreases the number of crossings with C_1, \dots, C_k . So

$$\sum_{i=1}^k \text{cr}(C_i, E) < \sum_{i=1}^k \text{cr}(C_i, D^n) = n \cdot \sum_{i=1}^k \text{cr}(C_i, D), \tag{58}$$

contradicting (54). ■

In Section 10 we derive from our results two further propositions on curves on compact orientable surfaces:

PROPOSITION 14. *For each non-null-homotopic closed curve C on a compact orientable surface S there exists a primitive closed curve D , unique up to homotopy, and a unique $n \in \mathbb{N}$ such that $C \sim D^n$.*

(This generalizes a result of Marden, Richards, and Rodin [12].)

PROPOSITION 15. *Let B and C be closed curves on a compact orientable surface S such that $\text{mincr}(B, D) = \text{mincr}(C, D)$ for each closed curve D . Then $B \sim C$ or $B \sim C^{-1}$.*

4. THE MAIN LEMMA

Now we are ready to prove our “main lemma”:

MAIN LEMMA. *Let $G = (V, E)$ be an eulerian graph embedded on a compact orientable surface S . If G is tight, then the straight decomposition of G forms a minimally crossing collection of primitive closed curves.*

(In Theorem 5 we shall see that also the reverse implication holds.)

Proof. We may assume that S is not the sphere. Let G be tight, and let it form a counterexample such that the number of vertices of degree at least 6 is as small as possible. We show that this number is 0, i.e.,

CLAIM 1. *Each vertex of G has degree at most 4.*

Proof of Claim 1. Consider G in a neighbourhood of a vertex v of degree at least 6:

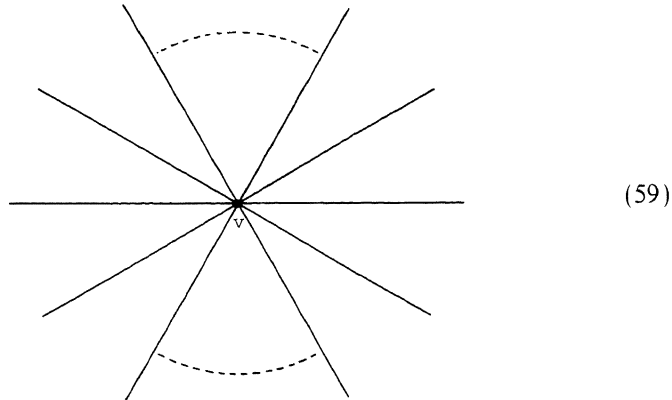

Replace G in this neighbourhood by:

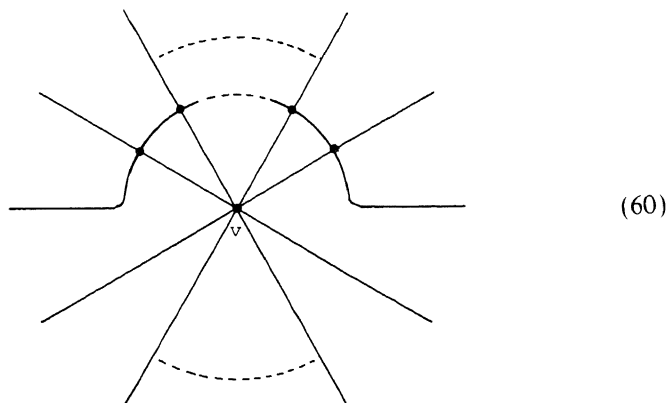

So in the modified graph, v has degree $\deg_G(v) - 2$, while there are $\frac{1}{2}\deg_G(v) - 1$ new vertices, each of degree 4.

It is not difficult to see that the modified graph is tight again. Moreover, the conclusion of the lemma is invariant under this modification. Hence, after a finite number of such modifications, we arrive at a graph forming a counterexample with all degrees being at most 4. ■

Now let \mathcal{D} be the straight decomposition of G . Let S' be the universal covering surface of S , with respect to some, for the moment arbitrary, point p in S . Let $\rho: S' \rightarrow S$ be the projection. Now $\rho^{-1}[G]$ forms an infinite graph G' , embedded on S' , with vertex set $V' := \rho^{-1}[V]$ (note that this is a countable subset of S' , without accumulation points).

Again, at any vertex of G' , we can “match” opposite edges, yielding the straight decomposition \mathcal{D}' of the edges of G' into cycles and infinite paths—call them just *curves*. Clearly, the curves in \mathcal{D}' are exactly the liftings of the cycles in \mathcal{D} . Since, by assumption, the conclusion of the lemma does not hold for G , by Propositions 8 and 10 there exists a curve in \mathcal{D}' which is a cycle or which is a self-intersecting infinite path, or there exist two curves in \mathcal{D}' intersecting each other more than once. It follows that there exist parts of curves in \mathcal{D}' forming one of the following configurations in $S' (\simeq \mathbb{C})$:

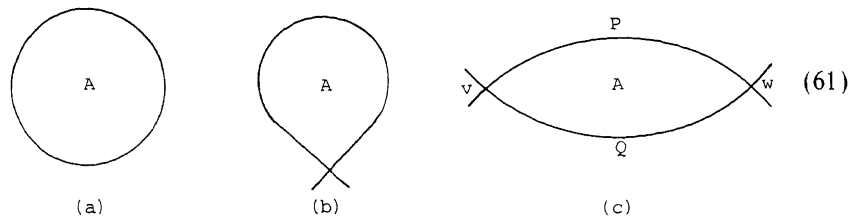

Each of these configurations consists of a non-self-intersecting cycle, made up from one or two parts of curves in \mathcal{D}' , enclosing the open set A , say. A covers a finite number of faces of G' . Choose the configuration so that A covers the smallest possible number of faces of G' .

CLAIM 2. *The configuration is of type (61)(c).*

Proof of Claim 2. Suppose the configuration is of type (61)(a) or (b). Then $\rho(A)$ forms a face of G . (Otherwise there is an edge of G' contained in A . Such an edge would be contained in a curve in \mathcal{D}' , which would create a configuration of type (61) enclosing a smaller number of faces of G' .)

In particular, we do not have configuration (61)(a), since it would yield a component of G which is a null-homotopic circuit. This is excluded by the definition of “tight” (see (27)(ii)).

If we have configuration (61)(b), the connectivity is preserved by opening $\rho(v)$ from $\rho(A)$ to the face opposite in $\rho(v)$ to $\rho(A)$. However, again this is excluded by the definition of "tight" (see (27)(i)). ■

We will use the notation v, w, P, Q as in (61)(c), where P and Q denote the open curves connecting v and w . Without loss of generality, v is equal to the point $\mathbf{1}$ in S' (the unit element of $\text{Hom}(p, p)$).

For any curve C in \mathcal{G}' intersecting A , if R is a component of this intersection, we call \bar{R} a chord of A . Now a similar argument to that used in proving Claim 2, is used in showing

CLAIM 3. *Each chord of A is a non-self-intersecting path connecting P and Q . No two chords intersect each other more than once. Each edge of G' contained in A belongs to some chord.*

Proof of Claim 3. Otherwise we would obtain one of the configurations (61) with a smaller number of faces of G' enclosed. ■

So restricted to \bar{A} the curves in \mathcal{G}' are not too wild. In particular, no chord of A contains v or w . So the regions indicated by J and F in a neighbourhood $N \simeq \mathbb{C}$ of v in

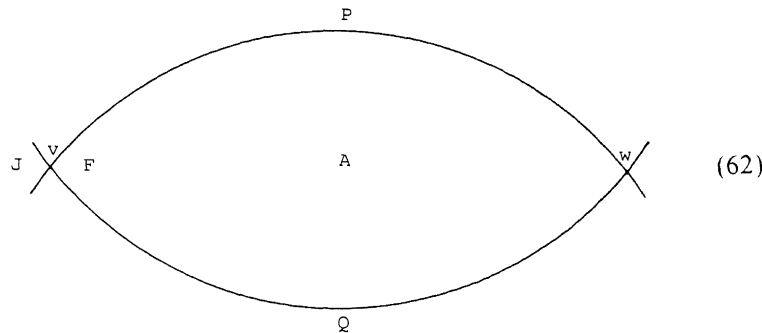

form intersections of faces of G' with N .

As G is tight, there exists a closed curve D on S for which the minimum number of crossings with the graph decreases when we open $\rho(v)$ from $\rho(J)$ to $\rho(F)$. That is, there exists a closed curve D on S (intersecting G only a finite number of times) with the following properties:

- (i) each intersection of D with G is either a crossing of D with an edge of G , or is an intersection of D with $\rho(v)$;
- (ii) each time D passes through $\rho(v)$, it goes from $\rho(J)$ to $\rho(F)$ or from $\rho(F)$ to $\rho(J)$; (63)
- (iii) $\gamma(D) < \text{mincr}(G, D)$;

where

$$\gamma(D) := \text{number of times } D \text{ crosses an edge of } G. \quad (64)$$

Let

$$n := n(D) := \text{number of times } D \text{ passes through } \rho(v). \quad (65)$$

Choose D satisfying (63) such that $n(D)$ is as small as possible. Since clearly $\gamma(D) + 2n(D) \geq \text{mincr}(G, D)$, we know that $n \geq 1$. So we can write

$$D = D_0 \cdot D_1 \cdot \dots \cdot D_{n-1}, \quad (66)$$

where D_0, \dots, D_{n-1} are closed curves in S with $D_0(1) = \dots = D_{n-1}(1) = \rho(v)$, so that for each $j = 0, \dots, n-1$,

$$\text{either (i) } D_{j-1} \text{ ends via } \rho(J) \text{ and } D_j \text{ starts via } \rho(F), \quad (67)$$

$$\text{or (ii) } D_{j-1} \text{ ends via } \rho(F) \text{ and } D_j \text{ starts via } \rho(J).$$

Here we say that a closed curve C starts via L if $\exists \varepsilon > 0 \forall \delta \in (0, \varepsilon): C(e^{i\delta}) \in L$. Similarly, C ends via L if $\exists \varepsilon > 0 \forall \delta \in (0, \varepsilon): C(e^{-i\delta}) \in L$. Moreover, we take indices of D_j modulo n (so $D_{m+n} = D_m$ if $m \in \mathbb{Z}$ and $0 \leq j \leq n-1$).

So each D_j intersects $\rho(v)$ only at its "end" point (i.e., $D_j(z) = \rho(v)$ if and only if $z = 1$). Furthermore, we may assume

- (i) no part of D is null-homotopic;
- (ii) (66) splits D into 'equal' parts (that is, for $j = 0, \dots, n-1: D(z) = D_j(z^n)$ if $2\pi j/n \leq \arg z \leq 2\pi(j+1)/n$);
- (iii) D_0 starts via $\rho(F)$.

Now let D' be the lifting of D to S' by $\mathbf{1}$. For $j \in \mathbb{Z}$, let $D'_j: [0, 1] \rightarrow S'$ be the j th part of D' ; that is,

$$D'_j(x) = D' \left(\frac{j+x}{n} \right) \quad \text{for } x \in [0, 1]. \quad (69)$$

So D'_j is a path in S' from

$$\text{hom}(D(e^{2\pi i j y/n})_{y \in [0,1]}) \quad \text{to} \quad \text{hom}(D(e^{2\pi i (j+1) y/n})_{y \in [0,1]}). \quad (70)$$

Let for $j \in \mathbb{Z}$, $\theta_j: S' \rightarrow S'$ denote the shift of S' over the homotopy class $\text{hom}(D(e^{2\pi i j y/n})_{y \in [0,1]}) \in \text{Hom}(p, p)$; that is,

$$\theta_j(\lambda) := [\text{hom}(D(e^{2\pi i j y/n})_{y \in [0,1]})] \cdot \lambda. \quad (71)$$

As is well-known, θ_j is an orientation-preserving homeomorphism of S' . It brings G' to G' and \mathcal{D}' to \mathcal{D}' . Give the following names to copies of objects in (62):

$$\begin{aligned} A_j &:= \theta_j(A), & P_j &:= \theta_j(P), & Q_j &:= \theta_j(Q), \\ v_j &:= \theta_j(v), & w_j &:= \theta_j(w), \\ J_j &:= \theta_j(J), & F_j &:= \theta_j(F). \end{aligned} \tag{72}$$

CLAIM 4. *If D_j starts via $\rho(F)$, then the image of D'_j is contained in \bar{A}_j .*

Proof of Claim 4. Without loss of generality, $j=0$. Note that $A_0 = A$. If D_0 starts via $\rho(F)$, then D'_0 starts via F (i.e., $D'_0[(0, \varepsilon)] \subseteq F$ for some $\varepsilon > 0$). If the image of D'_0 is not contained in \bar{A} , the path D'_0 should leave \bar{A} somewhere for the first time. First suppose this is by crossing \bar{P} :

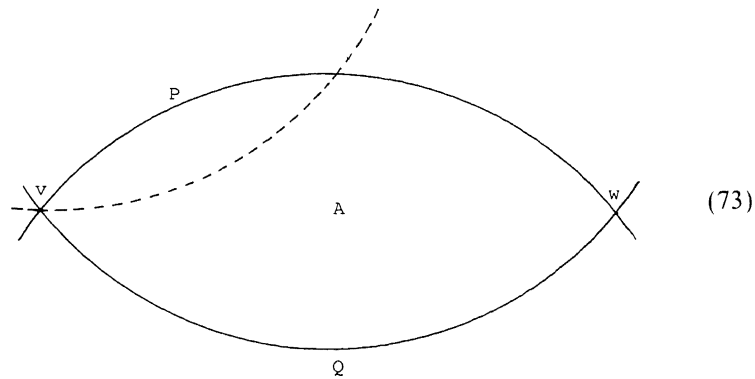

Now we shift part of D' as follows:

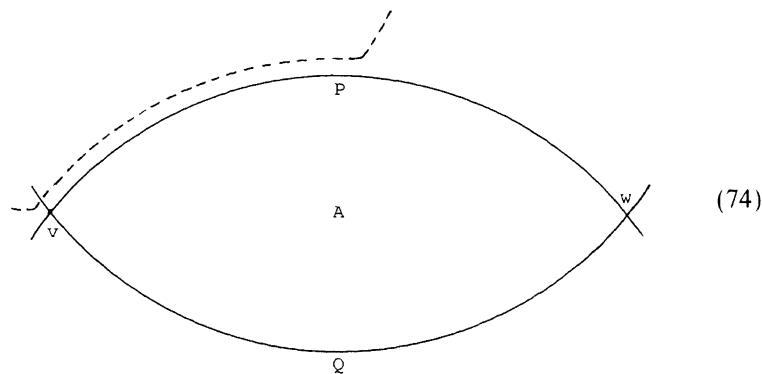

Let \tilde{D}' denote the shifted D' . We can shift D accordingly, yielding \tilde{D} (using the projection function $\rho: S' \rightarrow S$). By Claim 3, \tilde{D}' has no more crossings with edges of G' than D' has. Hence, \tilde{D} has no more crossings with edges of G than D has, i.e., $(\tilde{D}) \leq (D)$. So \tilde{D} satisfies (63). However, $n(\tilde{D}) = n(D) - 1$, contradicting the minimality of $n(D)$.

The case that D'_0 leaves \bar{A} by crossing \bar{Q} is similar. ■

CLAIM 5. If D_j starts via $\rho(F)$, and v_{j+1} belongs to chord \bar{R} of A_j , then D'_j has no other intersection with \bar{R} .

Proof of Claim 5. Without loss of generality, $j=0$. Suppose D'_0 has another intersection with \bar{R} ,

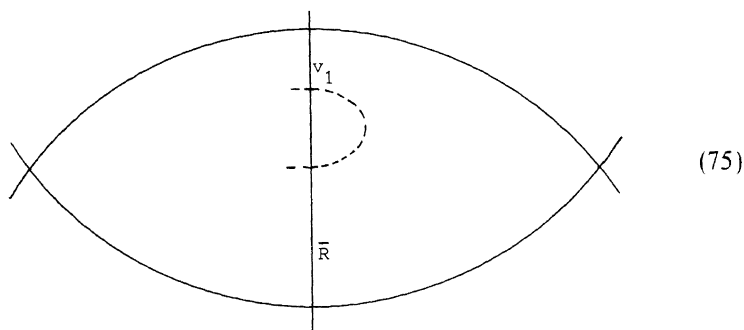

(v_1 can be one of the end points of \bar{R}). Now we shift part of D' as follows:

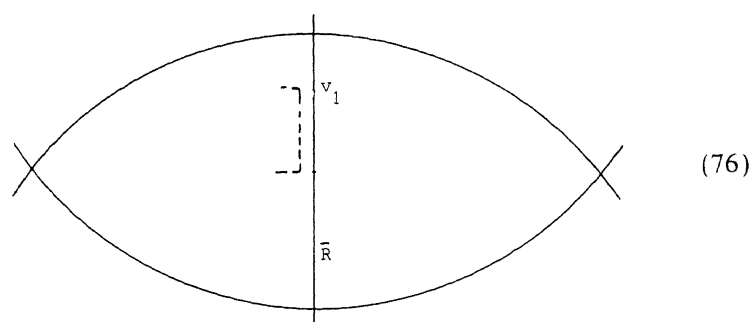

As in Claim 4, this yields (by projection to S) a closed curve $\tilde{D} \sim D$ satisfying (63) with $n(\tilde{D}) = n(D) - 1$, contradicting the minimality of $n(D)$. ■

By Claim 4, if D_j starts via $\rho(F)$, then v_{j+1} belongs to \bar{A}_j . There are four possibilities: (a) $v_{j+1} \in A_j$, (b) $v_{j+1} \in P_j$, (c) $v_{j+1} \in Q_j$, (d) $v_{j+1} = w_j$. By

Claim 5, this corresponds to the following figures, where the interrupted curve stands for D'_j :

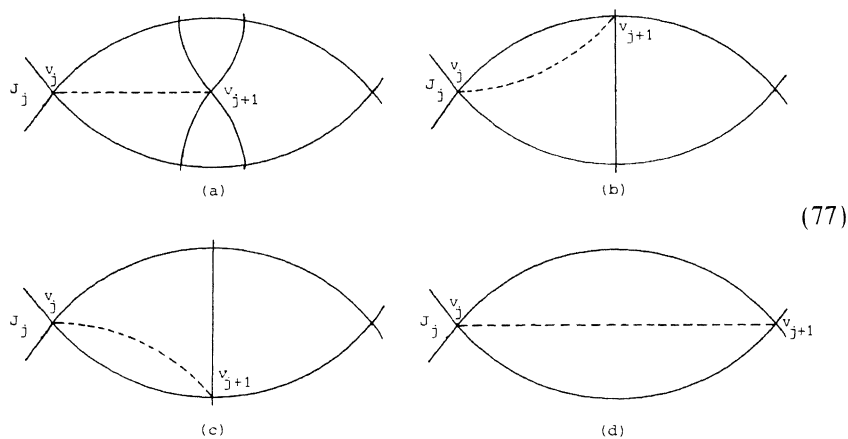

CLAIM 6. If D_j starts via $\rho(F)$, then D_j ends via $\rho(J)$.

Proof of Claim 6. Suppose to the contrary that D_j both starts and ends via $\rho(F)$. Without loss of generality $j=0$. Suppose first we are in case (77)(a), leading to the configuration

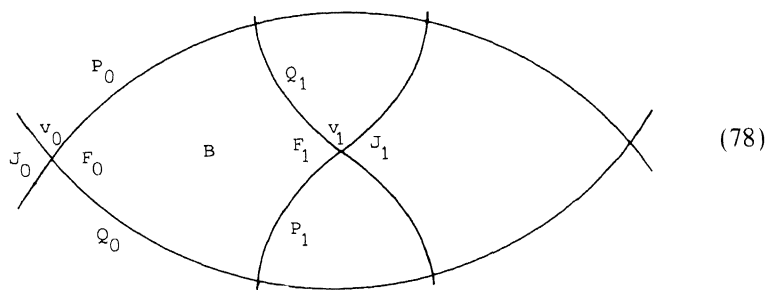

where B is the open region indicated, bounded by parts of $\overline{P_0}, \overline{Q_1}, \overline{P_1}$, and $\overline{Q_0}$. So $B \subseteq A_0 \cap A_1$ (since by Claim 3 applied to A_1 , P_1 intersects Q_0 only once and Q_1 intersects P_0 only once).

Clearly, there exists a continuous function $\varphi: \overline{A_0} \rightarrow \overline{B}$ with the following properties:

- (i) $\varphi|_B = \text{id}|_B$ (the identical function on \overline{B});
- (ii) $\varphi[\overline{A_0} \setminus \overline{B}] \subseteq \overline{P_1} \cup \overline{Q_1}$;
- (iii) $\varphi[\overline{P_0} \setminus \overline{B}] \subseteq \overline{Q_1}$;
- (iv) $\varphi[\overline{Q_0} \setminus \overline{B}] \subseteq \overline{P_1}$.

The function $\theta_1^{-1}: S' \rightarrow S'$ is a continuous function, without fixed points (as D_0 is not null-homotopic, by (67)(i)), so that $\theta_1^{-1}[\overline{A_1}] = \overline{A_0}$. Hence $\varphi \circ \theta_1^{-1}$ is a continuous function with $\varphi \circ \theta_1^{-1}[\overline{B}] \subseteq \overline{B}$. As \overline{B} is homeomorphic to a compact convex set, by Brouwer's fixed point theorem there exists an $r \in \overline{B}$ with $\varphi(\theta_1^{-1}(r)) = r$.

If $\theta_1^{-1}(r) \in \overline{B}$, then $r = \varphi(\theta_1^{-1}(r)) = \theta_1^{-1}(r)$, contradicting the fact that θ_1^{-1} has no fixed points.

If $\theta_1^{-1}(r) \in \overline{A_0} \setminus \overline{B}$, then $r = \varphi(\theta_1^{-1}(r)) \in \overline{P_1} \cup \overline{Q_1}$. If $r \in \overline{P_1}$ then $\theta_1^{-1}(r) \in \overline{P_0} \setminus \overline{B}$ and hence $r = \varphi(\theta_1^{-1}(r)) \in \overline{Q_1} \cap \overline{B}$, implying $r = v_1$, whence $v_1 = \varphi(\theta_1^{-1}(v_1)) = \varphi(v_0) = v_0$ —a contradiction. If $r \in \overline{Q_1}$ a contradiction follows similarly.

The cases (77)(b), (c), and (d) lead similarly (in fact, more simply) to contradictions. ■

As a direct consequence we have:

CLAIM 7. *Each D_j starts via $\rho(F)$ and ends via $\rho(J)$.*

Proof of Claim 7. By (68)(iii) we know that D_0 starts via $\rho(F)$. Hence, by (67) and Claim 6, it follows inductively that each D_j starts via $\rho(F)$ and ends via $\rho(J)$. ■

We next study the subset

$$Y := \bigcup_{j \in \mathbb{Z}} \overline{A_j} \quad (80)$$

of S' , and curves in \mathcal{D}' entering Y . Consider any curve C in \mathcal{D}' entering Y . That is, we can write

$$C = (\dots, e_0, u_0, e_1, u_1, e_2, u_2, e_3, u_3, \dots). \quad (81)$$

where e_i is an edge connecting vertices u_{i-1} and u_i ($i \in \mathbb{Z}$), so that $e_0 \not\subseteq Y$, while $u_0 \in Y$ (we consider edges as *open* curves). This implies $e_1 \subseteq Y$.

CLAIM 8. *There exists a number $h \geq 1$ such that $e_1, \dots, e_h \subseteq Y$ and $e_{h+1} \not\subseteq Y$ and such that D' crosses at least one of the edges e_1, \dots, e_h .*

Proof of Claim 8. I. Let $H := \{h \geq 1 \mid e_1, \dots, e_h \subseteq Y\}$. We first show that for only finitely many j the set $\overline{A_j}$ intersects $\bigcup_{h \in H} e_h$. Suppose this is not the case. Then for some j with $0 \leq j < n$ there exist infinitely many $m \in \mathbb{Z}$ so that $\overline{A_{mn+j}}$ intersects $\bigcup_{h \in H} e_h$.

Since $\overline{A_{mn+j}} = \theta_{mn+j}(\overline{A})$, and since \overline{A} contains only finitely many edges, there exists an edge e of G' contained in \overline{A} so that $e_{h'} = \theta_{m'n+j}(e)$ and $e_{h'} =$

$\theta_{m'n+j}(e)$ for some $h', h'' \in H$ and $m', m'' \in \mathbb{Z}$ with $m' \neq m''$. Without loss of generality, $h' \leq h''$. If $h' = h''$, we would have

$$e = \theta_{m'n+j}^{-1}(\theta_{m'n+j}(e)) = \theta_{(m'-m'')n}(e), \tag{82}$$

a contradiction (as θ_x has no fixed points if $x \neq 0$). If $h' < h''$, then

$$e_{h''} = \theta_{m'n+j}(\theta_{m'n+j}^{-1}(e_{h'})) = \theta_{(m'-m'')n}(e_{h'}), \tag{83}$$

whence, by symmetry, $e_{h''-h'} = \theta_{(m'-m'')n}(e_0)$. This contradicts the facts that $e_0 \notin Y$, $e_{h''-h'} \subseteq Y$ (since $0 < h'' - h' \leq h'' \in H$), and $\theta_{(m'-m'')n}(Y) = Y$.

II. Since each $\overline{A_j}$ contains only a finite number of edges of G' , and since (by definition of Y and H) e_h is contained in some $\overline{A_j}$ when $h \in H$, we know from part I of this proof that H is finite. From now on, let h be the largest number in H . So $e_{h+1} \not\subseteq Y$. We show that D' crosses at least one of e_1, \dots, e_h .

Let j be the largest integer so that $\overline{A_j}$ intersects $\bigcup_{h \in H} e_h$ (j exists by part I of this proof). Let I be the subpath

$$I = (u_0, e_1, u_1, \dots, e_h, u_h) \tag{84}$$

of C . We now consider four cases.

Case A. For j we are in situation (77)(a):

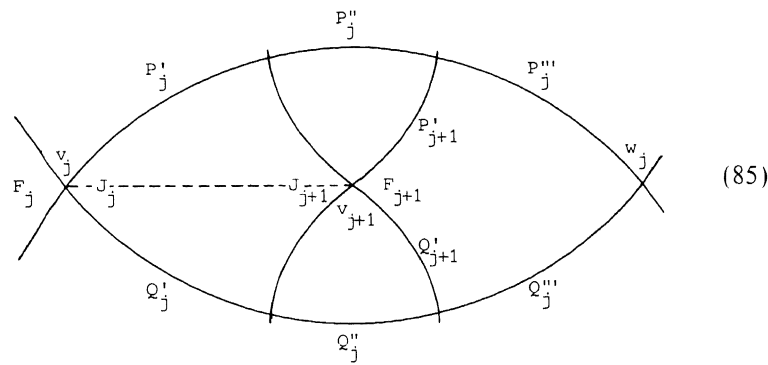

Note that parts P'''_j of P_j and Q'''_j of Q_j are fully contained in $\overline{A_{j+1}}$ (since by Claim 3 applied to A_{j+1} , P_{j+1} has no second intersection with P'''_j , and Q_{j+1} has no second intersection with Q'''_j). Since none of e_1, \dots, e_h is contained in $\overline{A_{j+1}}$ (by the maximality of j), it follows that I does not intersect $\overline{P_{j+1}} \cup \overline{P'''_j} \cup \overline{Q'''_j} \cup \overline{Q_{j+1}}$. Hence I contains one of the chords of A_j connecting $\overline{P'_j} \cup \overline{P''_j}$ and $\overline{Q'_j} \cup \overline{Q''_j}$ as a subcurve. So I contains an edge crossing D'_j .

Case B. For j we are in situation (77)(b):

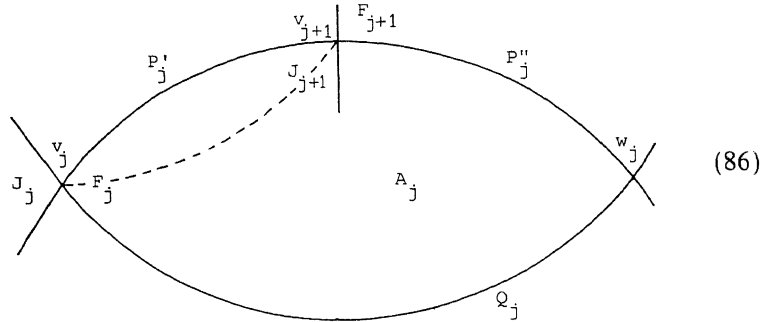

Note that part $\overline{P'_j}$ of $\overline{P_j}$ is fully contained in $\overline{Q_{j+1}}$, since P_j and Q_j contain the same number of vertices (by Claim 3), implying that also P_j and Q_{j+1} contain the same number of vertices (as Q_{j+1} is a shift of Q_j).

In particular, $\overline{P'_j} \subseteq \overline{A_{j+1}}$. Since I does not intersect $\overline{A_{j+1}}$, it follows that I does not intersect $\overline{P'_j}$. Hence I contains one of the chords of A_j connecting P_j and Q_j as a subcurve. So I contains an edge crossing D'_j .

Case C. For j we are in situation (77)(c). Similar to Case B.

Case D. For j we are in situation (77)(d). Since I does not intersect $\overline{A_{j+1}}$ we know that I cannot contain $\overline{P_j}$ or $\overline{Q_j}$ as a subcurve. Therefore, I contains one of the chords of A_j connecting P_j and Q_j as a subcurve. So I contains an edge crossing D'_j . ■

Consider now the covering surface S'' of S generated by D (cf. Section 2). Let $D'' : S_1 \rightarrow S''$ be the lifting of D to S'' . So D'' is homotopic to the unit circle under the homeomorphism of S'' and $\mathbb{C} \setminus \{0\}$. Let again $\psi : S' \rightarrow S''$ denote the quotient map (i.e., $\psi(\lambda) = \langle \lambda \rangle$), and let $\rho' : S'' \rightarrow S$ denote the projection (i.e., $\rho'(\langle \lambda \rangle) = q$ if $\lambda \in \text{Hom}(p, q)$). Let $G'' := (\rho')^{-1}[G] = \psi[G']$ be the "lifting" of G to S'' . Again, the edges of G'' can be decomposed into cycles and infinite paths ("curves") so that in each vertex two opposite edges are consecutively in the same curve. Let \mathcal{D}'' denote the collection of these curves. So \mathcal{D}'' corresponds to the projection of \mathcal{D}' to S'' .

Let $Y' := \psi[Y] = \bigcup_{j \in \mathbb{Z}} \psi[\overline{A_j}]$. Then $Y' = \bigcup_{j=0}^{n-1} \psi[\overline{A_j}]$, since $\psi[\overline{A_{n+j}}] = \psi[\overline{A_j}]$ for all $j \in \mathbb{Z}$.

So Y' is compact and contains D'' . Moreover, S'' is homeomorphic to $\mathbb{C} \setminus \{0\}$ in such a way that D'' is homotopic to the unit circle. Hence there exist closed curves B_1 and B_2 in S'' , following the inner and the outer boundary of Y' , respectively. We take B_1 and B_2 so that they are outside Y' , but close and parallel to the two boundaries, so that any edge $e \in Y'$ with one end point in Y' is crossed once and any edge $e \notin Y'$ with both

end points in Y' is crossed twice, and so that there are no further intersections with edges of G'' .

Note that both B_1 and B_2 are homotopic to D'' . Hence both $\rho' \circ B_1$ and $\rho' \circ B_2$ are homotopic to $\rho' \circ D'' = D$.

CLAIM 9. $\text{cr}(G'', B_1) + \text{cr}(G'', B_2) \leq 2\gamma(D)$.

Proof of Claim 9. Let Ω be the set of pairs (e, u) where e is an edge of G'' with $e \not\subseteq Y'$ and where u is an end point of e with $u \in Y'$. So $\text{cr}(G'', B_1) + \text{cr}(G'', B_2) \leq |\Omega|$.

Consider all subcurves

$$(e'_0, u'_0, e'_1, u'_1, \dots, e'_h, u'_h, e'_{h+1}) \tag{87}$$

of curves in \mathcal{D}'' so that $e'_0 \not\subseteq Y'$ and $e'_{h+1} \not\subseteq Y'$, while $e'_1 \cup \dots \cup e'_h \subseteq Y'$. By Claim 8, each pair $(e, u) \in \Omega$ gives a curve (87) with $e'_0 = e$ and $u'_0 = u$. So, identifying (87) with its reverse, there are $\frac{1}{2}|\Omega|$ such subcurves. By Claim 8 again, D'' crosses at least one of the edges e'_1, \dots, e'_h . So D'' crosses at least $\frac{1}{2}|\Omega|$ edges of G'' . Hence D crosses at least $\frac{1}{2}|\Omega|$ edges of G , i.e., $\gamma(D) \geq \frac{1}{2}|\Omega|$. Therefore,

$$2\gamma(D) \geq |\Omega| \geq \text{cr}(G'', B_1) + \text{cr}(G'', B_2). \quad \blacksquare \tag{88}$$

By symmetry we may assume $\text{cr}(G'', B_1) \leq \gamma(D)$. Then

$$\text{cr}(G, \rho' \circ B_1) = \text{cr}(G'', B_1) \leq \gamma(D) < \text{mincr}(G, D), \tag{89}$$

by (63)(iii). Since $\rho' \circ B_1 \sim \rho' \circ D'' = D$, this contradicts the definition of $\text{mincr}(G, D)$. \blacksquare

5. PROOF OF THEOREM 1

We now prove:

THEOREM 1. *Let G be an eulerian graph embedded on a compact orientable surface S . Then the edges of G can be decomposed into cycles C_1, \dots, C_t in such a way that for each closed curve D on S*

$$\text{mincr}(G, D) = \sum_{i=1}^t \text{mincr}(C_i, D). \tag{90}$$

Proof. First note that the inequality \geq in (90) trivially holds for any decomposition of the edges of G into cycles C_1, \dots, C_t , since if $\tilde{D} \sim D$ is such that $\text{cr}(G, \tilde{D}) = \text{mincr}(G, D)$, then

$$\text{mincr}(G, D) = \text{cr}(G, \tilde{D}) = \sum_{i=1}^t \text{cr}(C_i, \tilde{D}) \geq \sum_{i=1}^t \text{mincr}(C_i, D). \tag{91}$$

To see the reverse inequality, suppose $G = (V, E)$ forms a counterexample with

$$\sum_{v \in V} 2^{\deg(v)} \quad (92)$$

as small as possible (where $\deg(v)$ denotes the degree of v in G).

Then G is tight: if G had a component which is a null-homotopic circuit, we could remove this circuit without changing $\text{mincr}(G, D)$ for any closed curve D . Since the sum (92) does decrease, the edges of the smaller graph can be decomposed into cycles satisfying (90), and hence also for the original graph such a decomposition would exist.

Similarly, suppose the connectivity would be preserved by opening a vertex v from face F' to face F'' . Let G' be the graph after this opening. As for G' the sum (92) is smaller than for G , we can split the edges of G' into cycles satisfying (90), implying that the same holds for the original graph G .

So G is tight, and therefore, by the Main Lemma, the straight decomposition forms a minimally crossing collection of primitive closed curves C_1, \dots, C_t . By Proposition 12, for any closed curve D there exists $\tilde{D} \sim D$ so that $\text{cr}(C_i, \tilde{D}) = \text{mincr}(C_i, D)$ for $i = 1, \dots, t$. Hence

$$\text{mincr}(G, D) \leq \text{cr}(G, \tilde{D}) = \sum_{i=1}^t \text{cr}(C_i, \tilde{D}) = \sum_{i=1}^t \text{mincr}(C_i, D). \quad \blacksquare \quad (93)$$

6. PROOF OF THEOREM 2

Using the duality relation of graphs embedded on a surface we derive from Theorem 1:

THEOREM 2. *Let $G = (V, E)$ be a bipartite graph embedded on a compact orientable surface S , and let C_1, \dots, C_k be cycles in G . Then there exist closed curves $D_1, \dots, D_k: S_1 \rightarrow S$ such that (i) no D_i intersects V , (ii) each edge of G is crossed by exactly one D_j and by this D_j only once, (iii) for each $i = 1, \dots, k$:*

$$\text{minlength}_G(C_i) = \sum_{j=1}^k \text{mincr}(C_i, D_j). \quad (94)$$

Proof. We can extend (the embedded) G to a bipartite graph L embedded on S , containing G as a subgraph, so that each face of L (i.e., component of $S \setminus L$) is simply connected (i.e., homeomorphic to \mathbb{C}). Let $d := \max\{\text{minlength}_G(C_i) \mid i = 1, \dots, k\}$. By inserting d new vertices on each edge of L not occurring in G , we obtain a bipartite graph H satisfying

$$\text{minlength}_G(C_i) = \text{minlength}_H(C_i) \quad (95)$$

for $i = 1, \dots, k$.

Consider a dual graph H^* of H on S . Since H is bipartite, H^* is eulerian. Hence by the theorem, the edges of H^* can be decomposed into cycles D_1, \dots, D_r such that for any closed curve C on S

$$\text{mincr}(H^*, C) = \sum_{j=1}^r \text{mincr}(D_j, C). \tag{96}$$

Now for each $i = 1, \dots, k$, $\text{mincr}(H^*, C_i) = \text{minlength}_H(C_i) = \text{minlength}_G(C_i)$, and (94) follows. ■

Remark. The proof of Theorem 2 also gives the following. Let $G = (V, E)$ be a bipartite graph embedded on a compact orientable surface S , such that each face is simply connected. Then there exist closed curves $D_1, \dots, D_r: S_1 \rightarrow S$ such that (i) no D_j intersects V , (ii) each edge of G is crossed by exactly one D_j and by that D_j only once, (iii) for each cycle C in G

$$\text{minlength}_G(C) = \sum_{j=1}^r \text{mincr}(C, D_j). \tag{97}$$

In this statement we cannot delete the condition that each face be simply connected, as is shown by the following example:

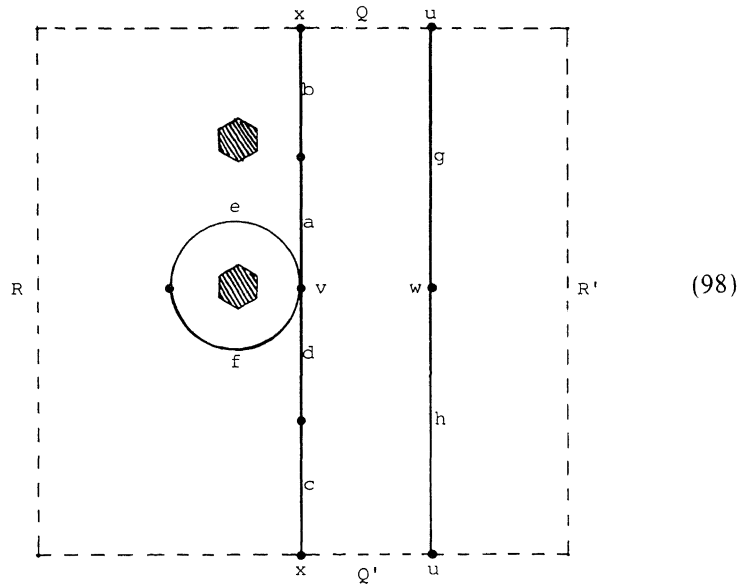

The surface is obtained from the square by identifying R and R' and identifying Q and Q' (thus obtaining a torus), and next deleting the interiors

of the two hexagons and identifying their boundaries (in such a way that the surface obtained is orientable). For $i = 0, 1, 2, \dots$, let C_i be the cycle in G which, starting in v , first follows e and f once, and next follows the cycle a, b, c, d i times. Then $\text{minlength}_G(C_i) = 4i + 2$. Suppose now that D_1, \dots, D_t are closed curves as above. Choose an arbitrary path $P: [0, 1] \rightarrow S$ from v to w . Then C_i is homotopic to the closed curve \tilde{C}_i obtained by, starting from v , first following e and f , next following P , then following the cycle g, h i times, and finally following P back from w to v . Hence, for each i ,

$$\begin{aligned}
 4i + 2 &= \text{minlength}_G(C_i) = \sum_{j=1}^t \text{mincr}(C_i, D_j) \\
 &\leq \sum_{j=1}^t \text{cr}(\tilde{C}_i, D_j) \\
 &= \sum_{j=1}^t (\text{cr}(C_0, D_j) + 2 \cdot \text{cr}(P, D_j) + i \cdot \text{cr}((w, g, u, h, w), D_j)) \\
 &= \sum_{j=1}^t (\text{cr}(C_0, D_j) + 2 \cdot \text{cr}(P, D_j)) + 2i. \tag{99}
 \end{aligned}$$

As the first term in this last sum is independent of i , this is a contradiction.

6. PROOF OF THEOREM 3

Using the polarity relation of convex cones in euclidean space we derive from Theorem 2 the following "homotopic circulation theorem":

THEOREM 3. *Let $G = (V, E)$ be a graph embedded on a compact orientable surface S , and let $c: E \rightarrow \mathbb{Q}_+$ ("capacity" function). Let C_1, \dots, C_k be cycles in G , pairwise not homotopic, and let $d_1, \dots, d_k \in \mathbb{Q}_+$ ("demands"). Then there exist cycles $\Gamma_1, \dots, \Gamma_u$ in G and $\lambda_1, \dots, \lambda_u \geq 0$ such that*

$$\begin{aligned}
 \text{(i)} \quad & \sum_{j=1, \Gamma_j \sim C_i}^u \lambda_j = d_i \quad (i = 1, \dots, k), \\
 \text{(ii)} \quad & \sum_{j=1}^u \lambda_j \cdot \chi^{\Gamma_j}(e) \leq c(e) \quad (e \in E),
 \end{aligned} \tag{100}$$

if and only if for each closed curve D on S not intersecting V we have

$$\sum_{i=1}^k d_i \cdot \text{mincr}(C_i, D) \leq \sum_{e \in E} c(e) \cdot \chi^D(e). \tag{101}$$

Proof. Necessity. Suppose there exist $\Gamma_1, \dots, \Gamma_u, \lambda_1, \dots, \lambda_u$ as required, and let D be a closed curve on S not intersecting V . Then

$$\begin{aligned}
 \sum_{e \in E} c(e) \cdot \chi^D(e) &\leq \sum_{e \in E} \chi^D(e) \sum_{j=1}^u \lambda_j \cdot \chi^{\Gamma_j}(e) \\
 &= \sum_{j=1}^u \lambda_j \sum_{e \in E} \chi^D(e) \cdot \chi^{\Gamma_j}(e) \\
 &= \sum_{j=1}^u \lambda_j \text{cr}(\Gamma_j, D) \geq \sum_{j=1}^u \lambda_j \text{mincr}(\Gamma_j, D) \\
 &\geq \sum_{i=1}^k \text{mincr}(C_i, D) \sum_{\substack{j=1 \\ \Gamma_j \sim C_i}}^u \lambda_j = \sum_{i=1}^k d_i \text{mincr}(C_i, D). \quad (102)
 \end{aligned}$$

Sufficiency. Suppose (101) is satisfied for each closed curve D not intersecting V . Let K be the convex cone in $\mathbb{R}^k \times \mathbb{R}^E$ generated by the vectors

$$\begin{aligned}
 (\varepsilon_i; \chi^\Gamma) &\quad (i = 1, \dots, k; \Gamma \text{ cycle in } G \text{ with } \Gamma \sim C_i); \\
 (\mathbf{0}; \varepsilon_e) &\quad (e \in E).
 \end{aligned} \quad (103)$$

Here ε_i denotes the i th unit bases vector in \mathbb{R}^k . Similarly, ε_e denotes the e th unit basis vector in \mathbb{R}^E . $\mathbf{0}$ denotes the origin in \mathbb{R}^k .

Although (103) gives infinitely many vectors, K is finitely generated. This can be seen as follows. For each fixed i , call a cycle $\Gamma \sim C_i$ *minimal* if there is no cycle $\Gamma' \sim C_i$ with $\chi^{\Gamma'}(e) \leq \chi^\Gamma(e)$ for each edge e , and with strict inequality for at least one edge e . So the set $\{\chi^\Gamma \mid \Gamma \text{ minimal cycle with } \Gamma \sim C_i\}$ forms an antichain in \mathbb{Z}_+^E and is therefore finite. Since we can restrict, for each $i = 1, \dots, k$, the χ^Γ in (103) to those with Γ minimal, K is finitely generated.

What we must show is that the vector $(d; c)$ belongs to K , where $d := (d_1, \dots, d_k)$. By Farkas's lemma, it suffices to show that for each vector $(p; b) \in \mathbb{Q}^k \times \mathbb{Q}^E$ with nonnegative inner product with each of the vectors (103), also the inner product with $(d; c)$ is nonnegative. So let $(p; b)$ have nonnegative inner product with each of (103). This is equivalent to

$$\begin{aligned}
 \text{(i)} \quad p_i + \sum_{e \in E} b(e) \chi^\Gamma(e) &\geq 0 && (i = 1, \dots, k; \Gamma \text{ cycle in } G \text{ with } \Gamma \sim C_i); \\
 \text{(ii)} \quad b(e) &\geq 0 && (e \in E).
 \end{aligned} \quad (104)$$

Suppose $(p; b)(d; c)^T < 0$. By increasing b slightly, we may assume that $b(e) > 0$ for all $e \in E$. Next, by blowing up $(p; b)$, we may assume that each entry in $(p; b)$ is an even integer. Let G' be the graph arising from G by replacing each edge e by a path of length $b(e)$. Each cycle C_i directly gives a cycle C'_i in G' . Then by (104)(i),

$$-p_i \leq \text{minlength}_{G'}(C'_i) \quad \text{for } i = 1, \dots, k. \quad (105)$$

Since G' is bipartite, by Theorem 2 there exist closed curves D_1, \dots, D_t on S such that (i) no D_j intersects the vertex set of G' , (ii) each edge of G' is intersected by exactly one D_j and only once by that D_j , and (iii) for each $i = 1, \dots, k$

$$\text{minlength}_{G'}(C'_i) = \sum_{j=1}^t \text{mincr}(C'_i, D_j). \quad (106)$$

Note that (ii) implies

$$b(e) \geq \sum_{j=1}^t \chi^{D_j}(e). \quad (107)$$

Therefore, using (101), (105), (106), and (107),

$$\begin{aligned} \sum_{e \in E} b(e) c(e) &= \sum_{j=1}^t \sum_{e \in E} \chi^{D_j}(e) c(e) \\ &\geq \sum_{j=1}^t \sum_{i=1}^k d_i \cdot \text{mincr}(C'_i, D_j) \\ &= \sum_{i=1}^k d_i \cdot \sum_{j=1}^t \text{mincr}(C'_i, D_j) \\ &= \sum_{i=1}^k d_i \cdot \text{minlength}_{G'}(C'_i) \geq - \sum_{i=1}^k p_i d_i. \end{aligned} \quad (108)$$

So $(p; b) \cdot (d; c)^T \geq 0$. ■

Remark. In Note 3 in Section 1 we mentioned some special cases where we can take the λ_i in Theorem 3 integral. Here we give an example to show that in general for the λ_i to be integral, it is not enough to require that all capacities and demands be integral such that the difference in (101) is even for each D :

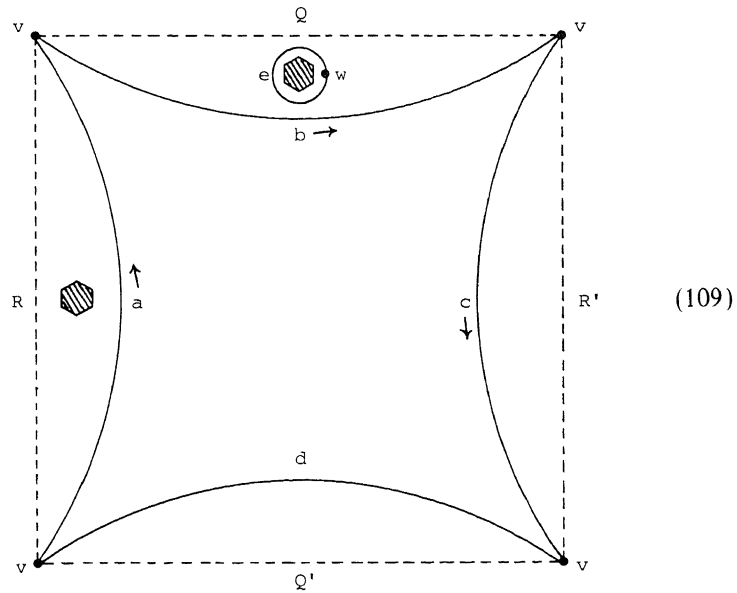

The surface is obtained from the square by identifying R and R' and identifying Q and Q' (thus obtaining a torus) and next deleting the interiors of the two hexagons and identifying their boundaries (in such a way that the surface obtained is orientable). The graph has two vertices, v and w , and four loops (a, b, c, d) at v and one loop (e) at w . Curve C_1 follows the edges a and b , and curve C_2 follows the edges b and c —in the directions indicated. Taking all capacities and demands equal to 1, we see that for each closed curve D not intersecting v and w , the difference in (101) is an even nonnegative integer. However, no edge-disjoint cycles homotopic to C_1 and C_2 , respectively, exist in G .

8. PROOF OF THEOREM 4

As a consequence of Theorem 3 we derive a “homotopic flow-cut theorem”:

THEOREM 4. *Let $G = (V, E)$ be a planar graph embedded in the complex plane \mathbb{C} . Let I_1, \dots, I_p be (the interiors of) some of the faces of G , including the unbounded face. Let P_1, \dots, P_k be paths in G with end points on the boundary of $I_1 \cup \dots \cup I_p$. Then there exist paths $P_{11}, \dots, P_{1t_1}, P_{21}, \dots, P_{2t_2}, \dots, P_{k1}, \dots, P_{kt_k}$ in G and rationals $\lambda_{11}, \dots, \lambda_{1t_1}, \lambda_{21}, \dots, \lambda_{2t_2}, \dots, \lambda_{k1}, \dots, \lambda_{kt_k} \geq 0$ such that*

$$\begin{aligned}
\text{(i)} \quad & P_{ij} \sim P_i \text{ in } \mathbb{C} \setminus (I_1 \cup \dots \cup I_p) \quad (i = 1, \dots, k; j = 1, \dots, t_i), \\
\text{(ii)} \quad & \sum_{j=1}^{t_i} \lambda_{ij} = 1 \quad (i = 1, \dots, k), \\
\text{(iii)} \quad & \sum_{i=1}^k \sum_{j=1}^{t_i} \lambda_{ij} \chi^{P_j}(e) \leq 1 \quad (e \in E),
\end{aligned} \tag{110}$$

if and only if for each path $D: [0, 1] \rightarrow \mathbb{C} \setminus (I_1 \cup \dots \cup I_p)$ connecting two points on the boundary of $I_1 \cup \dots \cup I_p$, not intersecting G only a finite number of times, we have:

$$\sum_{i=1}^k \text{mincr}(P_i, D) \leq \text{cr}(G, D). \tag{111}$$

Proof. Necessity. Similar to the proof of necessity in Theorem 3.

Sufficiency. Suppose the condition mentioned holds. We may assume that G is embedded on the 2-dimensional sphere S_2 , and that I_1, \dots, I_p are faces on S_2 . For each pair of vertices v, v' of G on the boundary of $I_1 \cup \dots \cup I_p$, say on the boundaries of I_j and $I_{j'}$, respectively, make a handle $H_{v,v'}$ with ends in I_j and $I_{j'}$. This yields the compact orientable surface S . Next, for each path P_i from, say, v to v' , we extend G by an edge, say e_i , connecting v and v' over the handle $H_{v,v'}$. It is easy to see that we can do this in such a way that the new edges do not intersect each other and do not intersect the “old” edges of G . Let G' denote the extended graph. Each P_i now has been “closed” to a cycle, say C_i , in G' . We apply Theorem 3, with $d_i := 1$ for $i = 1, \dots, k$, and $c(e) := 1$ for each edge e . Then the “circulation” described by (100) yields a “multi-commodity flow” described by (110). So it suffices to check condition (101) i.e., that for any closed curve D on S not intersecting V we have

$$\sum_{i=1}^k \text{mincr}(C_i, D) \leq \text{cr}(G', D). \tag{112}$$

We distinguish three cases.

Case 1. D is contained in $S_2 \setminus (I_1 \cup \dots \cup I_p)$. Let y be some point on D , let z be some point on the boundary of $I_1 \cup \dots \cup I_p$ (with $z \notin V$), let R be some path in $S_2 \setminus (I_1 \cup \dots \cup I_p)$ connecting z and y (such that R does not intersect V and intersects G only a finite number of times), and for $n \in \mathbb{N}$, let Q_n be the path from z to z which first follows R from z to y , then follows closed curve D n times, and next returns to z over R . Let r be the

number of edges intersected by R . Let D^n denote the closed curve with $D^n(z) := D(z^n)$ for $z \in S_1$. Then for all $n \in \mathbb{N}$,

$$\begin{aligned} n \cdot \sum_{i=1}^k \operatorname{mincr}(C_i, D) &= \sum_{i=1}^k \operatorname{mincr}(C_i, D^n) \\ &\leq \sum_{i=1}^k \operatorname{mincr}(P_i, Q_n) \\ &\leq \operatorname{cr}(G, Q_n) = 2r + n \cdot \operatorname{cr}(G', D). \end{aligned} \quad (113)$$

The first equality follows from Proposition 5 in Section 3. The first inequality follows from the fact that for each i , if $Q \sim Q_n$ is a path in $S_2 \setminus (I_1 \cup \dots \cup I_p)$ attaining $\operatorname{mincr}(P_i, Q_n)$, then, as a closed curve, Q is (freely) homotopic to D^n , and hence $\operatorname{mincr}(C_i, D^n) \leq \operatorname{cr}(C_i, Q) = \operatorname{cr}(P_i, Q) = \operatorname{mincr}(P_i, Q_n)$. The second inequality follows from (111). The last equality follows from the definition of path Q_n . Since (113) holds for each n , while r is fixed, (112) follows.

Case 2. D does not intersect $S_2 \setminus (I_1 \cup \dots \cup I_p)$. Now

$$\operatorname{cr}(G', D) = \sum_{i=1}^k \operatorname{cr}(C_i, D) \geq \sum_{i=1}^k \operatorname{mincr}(C_i, D). \quad (114)$$

Case 3. D intersects both $S_2 \setminus (I_1 \cup \dots \cup I_p)$ and its complement in S , say H . Then we can split D into paths D_1, D_2, \dots, D_{2u} such that for odd i , D_i is contained in $S_2 \setminus (I_1 \cup \dots \cup I_p)$ and connects two points on the boundary of $I_1 \cup \dots \cup I_p$, while for even i , D_i is contained in H , except for its end points. Then we have

$$\begin{aligned} \operatorname{cr}(G', D) &= \sum_{j=1}^u \operatorname{cr}(G, D_{2j-1}) + \sum_{j=1}^u \sum_{i=1}^k \chi^{D_{2j}}(e_i) \\ &\geq \sum_{j=1}^u \sum_{i=1}^k \operatorname{mincr}(P_i, D_{2j-1}) \\ &\quad + \sum_{j=1}^u \sum_{i=1}^k \chi^{D_{2j}}(e_i) \\ &= \sum_{i=1}^k \sum_{j=1}^u (\operatorname{mincr}(P_i, D_{2j-1}) + \chi^{D_{2j}}(e_i)) \\ &\geq \sum_{i=1}^k \operatorname{mincr}(C_i, D), \end{aligned} \quad (115)$$

thus proving (112). The first inequality here follows from (111). The second inequality can be seen as follows. Define for any two paths $P, Q: [0, 1] \rightarrow S_2 \setminus (I_1 \cup \dots \cup I_p)$ with $X := \{(x, y) \in [0, 1] \times [0, 1] \mid P(x) = Q(y)\}$ finite, the relation \approx on X

$$(x, y) \approx (x', y') \text{ if and only if the path } P(\lambda x' + (1 - \lambda)x)_{\lambda \in [0, 1]} \text{ is homotopic to the path } Q(\lambda y' + (1 - \lambda)y)_{\lambda \in [0, 1]} \quad (116)$$

(note that both paths connect $P(x) = Q(y)$ with $P(x') = Q(y')$). This defines an equivalence relation on X . Call a class *odd* if it contains an odd number of elements. Next define

$$\text{odd}(P, Q) := \text{number of odd classes of } \approx. \quad (117)$$

Clearly, $\text{cr}(P, Q) \geq \text{odd}(P, Q)$. It is not difficult to see that, if both P and Q have their end points on the boundary of $I_1 \cup \dots \cup I_p$, and if $\tilde{P} \sim P$, $\tilde{Q} \sim Q$ in $S_2 \setminus (I_1 \cup \dots \cup I_p)$, so that \tilde{P} and \tilde{Q} have a finite number of intersections, then $\text{odd}(\tilde{P}, \tilde{Q}) = \text{odd}(P, Q)$. This follows with the theory of simplicial approximation (cf. Seifert and Threlfall [25, Sect. 44]): Make triangulations Γ and Δ of $S_2 \setminus (I_1 \cup \dots \cup I_p)$ such that P and \tilde{P} follow edges of Γ and Q and \tilde{Q} follow edges of Δ , and such that the vertices and edges of Γ have only a finite number of intersections with those of Δ . Then \tilde{P} arises from P by a series of reroutings along triangles of Γ ; each such rerouting does not change $\text{odd}(P, Q)$. Similarly for Q .

Hence

$$\text{mincr}(P, Q) \geq \text{odd}(P, Q). \quad (118)$$

Therefore, for each fixed $i = 1, \dots, k$,

$$\begin{aligned} & \sum_{j=1}^u (\text{mincr}(P_i, D_{2j-1}) + \chi^{D_{2j}}(e_i)) \\ & \geq \sum_{j=1}^u (\text{odd}(P_i, D_{2j-1}) + \chi^{D_{2j}}(e_i)) \\ & \geq \text{odd}(C_i, D) = \text{mincr}(C_i, D). \end{aligned} \quad (119)$$

For the definition of $\text{odd}(C, D)$ for closed curves C, D we refer to Section 3. The second inequality in (119) follows from the fact that if two intersections of P_i and D_{2j-1} are equivalent according to (116), then they are equivalent intersections of C_i and D according to (45). Hence each odd class of intersections of C_i and D includes at least one odd class of intersections of P_i and D_{2j-1} for some $j = 1, \dots, u$, or contains at least one intersection of D_{2j} with e_i . ■

9. PROOF OF THEOREM 5

We finally show that the condition given in the “Main Lemma” is necessary and sufficient, which is the content of Theorem 5. As a preparation, we prove the following “cross-counting” lemma, based on an elementary exchange of summation.

LEMMA. *Let $G = (V, E)$ be an eulerian graph embedded on the compact orientable surface S . Let C_1, \dots, C_s be cycles in G and let $\lambda_1, \dots, \lambda_s > 0$ such that for each $e \in E$ we have $\sum_{i=1}^s \lambda_i \chi^{C_i}(e) \leq 1$. Then for each $i = 1, \dots, s$,*

$$\sum_{v \in V} \mu_i(v) (\frac{1}{2} \text{deg}(v) - 1) \geq \sum_{j=1}^s \lambda_j \cdot \text{mincr}(C_i, C_j), \tag{120}$$

where $\mu_i(v)$ denotes the number of times C_i passes through vertex v . Moreover, equality in (120) implies that C_i belongs to the straight decomposition of G .

Proof. We may assume that G has no parallel edges (we can put extra vertices on edges) and that no C_i arrives in a vertex v over an edge e and immediately leaves v over the same edge e (deleting such occurrences makes the statement to be proven stronger). For any $v \in V$, let $\delta(v)$ denote the set of edges incident to v . Denote for each $i = 1, \dots, s$ and each choice of $v \in V, e, e' \in \delta(v)$,

$$\begin{aligned} \mu_i(e, e') := & \text{the number of times cycle } C_i \text{ passes } v \text{ by going} \\ & \text{from } e \text{ to } e' \text{ or from } e' \text{ to } e. \end{aligned} \tag{121}$$

So $\mu_i(e, e') = 0$ if $e = e'$. Define, for $v \in V, e, e', e'', e''' \in \delta(v)$,

$$\tau(e, e', e'', e''') := \begin{cases} 1, & \text{if } e, e' \text{ crosses } e'', e'''; \\ \frac{1}{2}, & \text{if } e, e' \text{ semi-crosses } e'', e'''; \\ 0, & \text{otherwise.} \end{cases} \tag{122}$$

Here we say that e, e' crosses e'', e''' if e, e', e'', e''' are all distinct and if in the cyclic order of edges incident to v , we have e, e'', e', e''' or e, e''', e', e'' . Moreover, e, e' semi-crosses e'', e''' if $|\{e, e', e'', e'''\}| = 3$ and $|\{e, e'\} \cap \{e'', e'''\}| = 1$.

One easily checks that for $i, j = 1, \dots, s$,

$$\text{mincr}(C_i, C_j) \leq \frac{1}{4} \sum_{v \in V} \sum_{\substack{e, e', e'', \\ e''' \in \delta(v)}} \tau(e, e', e'', e''') \mu_i(e, e') \mu_j(e'', e'''). \tag{123}$$

Now for each $v \in V$ and $e, e' \in \delta(v)$ with $e \neq e'$,

$$\begin{aligned}
& \sum_{j=1}^s \lambda_j \sum_{\substack{e'', e''' \in \delta(v) \\ e'', e''' \text{ crosses} \\ e, e'}} \tau(e, e', e'', e''') \mu_j(e'', e''') \\
&= \sum_{\substack{e'', e''' \in \delta(v) \\ e'', e''' \text{ crosses} \\ e, e'}} \sum_{j=1}^s \lambda_j \cdot \mu_j(e'', e''') + \frac{1}{2} \sum_{\substack{e'', e''' \in \delta(v) \\ e'', e''' \text{ semi-crosses} \\ e, e'}} \sum_{j=1}^s \lambda_j \cdot \mu_j(e'', e''') \\
&= \sum_{\substack{e'' \in \delta(v) \\ e'' \neq e, e'}} \sum_{j=1}^s \lambda_j \left(\sum_{\substack{e''' \in \delta(v) \\ e'', e''' \text{ crosses} \\ e, e'}} \mu_j(e'', e''') + \frac{1}{2} \sum_{e''' \in \{e, e'\}} \mu_j(e'', e''') \right) \\
&\quad + \sum_{e'' \in \{e, e'\}} \sum_{j=1}^s \lambda_j \frac{1}{2} \left(\sum_{\substack{e''' \in \delta(v) \\ e''' \neq e, e'}} \mu_j(e'', e''') \right) \\
&\leq \sum_{\substack{e'' \in \delta(v) \\ e'' \neq e, e'}} \sum_{j=1}^s \lambda_j \sum_{e''' \in \delta(v)} \mu_j(e'', e''') \\
&= \sum_{\substack{e'' \in \delta(v) \\ e'' \neq e, e'}} \sum_{j=1}^s \lambda_j \cdot \chi^C(e'') \leq \deg(v) - 2. \tag{124}
\end{aligned}$$

Hence, by (123) and (124),

$$\begin{aligned}
& \sum_{v \in V} \mu_i(v)(\deg(v) - 2) \\
&= \frac{1}{2} \sum_{v \in V} \sum_{e, e' \in \delta(v)} \mu_i(e, e')(\deg(v) - 2) \\
&\geq \frac{1}{2} \sum_{v \in V} \sum_{e, e' \in \delta(v)} \mu_i(e, e') \\
&\quad \cdot \sum_{j=1}^s \lambda_j \sum_{e'', e''' \in \delta(v)} \tau(e, e', e'', e''') \mu_j(e'', e''') \\
&\geq 2 \cdot \sum_{j=1}^s \lambda_j \cdot \text{mincr}(C_i, C_j). \tag{125}
\end{aligned}$$

This shows (120).

Next suppose we have equality in (120). To show that C_i belongs to the straight decomposition, suppose $v \in V$, $e, e' \in \delta(v)$, $e \neq e'$, such that e and e' are not opposite edges and $\mu_i(e, e') \geq 1$. Equality in (120) implies equality throughout in (125). Let $e_1 = e, e_2, \dots, e_p, e_{p+1} = e', e_{p+2}, \dots, e_d$ be the edges

incident to v in cyclic order (so $d = \deg(v)$). Since e and e' are not opposite, we may assume $p \leq \frac{1}{2}d - 1$. Then

$$\begin{aligned} \sum_{\substack{e'', e''' \in \delta(v), \\ e'', e''' \text{ crosses} \\ e, e'}} \sum_{j=1}^s \lambda_j \cdot \mu_j(e'', e''') &= 2 \cdot \sum_{h=2}^p \sum_{g=p+2}^d \sum_{j=1}^s \lambda_j \cdot \mu_j(e_h, e_g) \\ &= 2 \cdot \sum_{h=2}^p \sum_{j=1}^s \lambda_j \sum_{g=p+2}^d \mu_j(e_h, e_g) \\ &\leq 2 \cdot \sum_{h=2}^p \sum_{j=1}^s \lambda_j \cdot \chi^{C_l}(e_h) \leq 2p - 2, \end{aligned} \quad (126)$$

and

$$\begin{aligned} &\frac{1}{2} \sum_{\substack{e'', e''' \in \delta(v) \\ e'', e''' \text{ semi-crosses} \\ e, e'}} \sum_{j=1}^s \lambda_j \cdot \mu_j(e'', e''') \\ &< \frac{1}{2} \sum_{\substack{e'', e''' \in \delta(v) \\ e'', e''' \text{ semi-crosses} \\ e, e'}} \sum_{j=1}^s \lambda_j \cdot \mu_j(e'', e''') + \sum_{j=1}^s \lambda_j \cdot \mu_j(e, e') \\ &= \frac{1}{2} \sum_{\substack{e'' \in \delta(v) \\ e'' \neq e, e'}} \sum_{j=1}^s \lambda_j (\mu_j(e, e'') + \mu_j(e', e'')) \\ &\quad + \frac{1}{2} \sum_{\substack{e''' \in \delta(v) \\ e''' \neq e, e'}} \sum_{j=1}^s \lambda_j (\mu_j(e, e''') + \mu_j(e', e''')) + \sum_{j=1}^s \lambda_j \cdot \mu_j(e, e') \\ &= \sum_{e'' \in \delta(v)} \sum_{j=1}^s \lambda_j \cdot (\mu_j(e, e'') + \mu_j(e', e'')) \\ &= \sum_{j=1}^s \lambda_j (\chi^{C_l}(e) + \chi^{C_l}(e')) \leq 2. \end{aligned} \quad (127)$$

This implies strict inequality in (124)—a contradiction. ■

This lemma is used in proving

THEOREM 5. *Let $G = (V, E)$ be an eulerian graph embedded on the compact orientable surface S . Then G is tight if and only if the straight decomposition of G forms a minimally crossing collection of primitive closed curves.*

Proof. The content of the “Main Lemma” being the “only if” part, we show here the “if” part. So let the straight decomposition $\mathcal{C} = (C_1, \dots, C_k)$

of G be a minimally crossing collection of primitive closed curves. We show that (27)(i) and (ii) are satisfied.

Condition (27)(ii) is trivial, since any component of G being a null-homotopic circuit would give a curve in \mathcal{D} which is not primitive.

Now to show (27)(i), suppose that the connectivity is preserved by opening vertex w from face F' to face F'' , where F' and F'' are opposite in w . Let G' be the graph obtained by this "opening" (cf. (26)). Since for each closed curve D on S

$$\sum_{i=1}^k \text{mincr}(C_i, D) \leq \text{mincr}(G, D) = \text{mincr}(G', D), \tag{128}$$

we know by Theorem 3 that in G' there exist cycles $C_{11}, \dots, C_{1t_1}, \dots, C_{k1}, \dots, C_{kt_k}$ and rationals $\lambda_{11}, \dots, \lambda_{1t_1}, \dots, \lambda_{k1}, \dots, \lambda_{kt_k} > 0$ such that

$$\begin{aligned} \text{(i)} \quad & C_{ij} \sim C_i && (i = 1, \dots, k; j = 1, \dots, t_i); \\ \text{(ii)} \quad & \sum_{j=1}^{t_i} \lambda_{ij} = 1 && (i = 1, \dots, k); \\ \text{(iii)} \quad & \sum_{i=1}^k \sum_{j=1}^{t_i} \lambda_{ij} \chi^{C_{ij}}(e) \leq 1 && (e \in E). \end{aligned} \tag{129}$$

By identifying the two new w' and w'' we obtain cycles in G satisfying the condition of the lemma. Call the cycle in G obtained from C_{ij} again C_{ij} . Then

$$\begin{aligned} & \sum_i \sum_{i'} \text{mincr}(C_i, C_{i'}) = \sum_{i,j} \sum_{i',j'} \lambda_{ij} \lambda_{i'j'} \text{mincr}(C_{ij}, C_{i'j'}) \\ & \leq \sum_{i,j} \lambda_{ij} \sum_{v \in V} \mu_{ij}(v) \left(\frac{1}{2} \text{deg}(v) - 1 \right) = \sum_{v \in V} \left(\frac{1}{2} \text{deg}(v) - 1 \right) \sum_{i,j} \lambda_{ij} \mu_{ij}(v) \\ & \leq \sum_{v \in V} \left(\frac{1}{2} \text{deg}(v) - 1 \right) \left(\frac{1}{2} \text{deg}(v) \right) = \sum_{\substack{i,i' \\ i \neq i'}} \text{cr}(C_i, C_{i'}) + 2 \sum_i \text{cr}(C_i) \\ & = \sum_i \sum_{i'} \text{mincr}(C_i, C_{i'}) \end{aligned} \tag{130}$$

(cf. Proposition 11 in Section 3), where i and i' range over $1, \dots, k, j$ over $1, \dots, t_i$, and j' over $1, \dots, t_{i'}$, and where $\mu_{ij}(v)$ denotes the number of times cycle C_{ij} passes through v .

So we have equality throughout. By the lemma this implies that each C_{ij}

belongs to the straight decomposition of G . Hence, as the C_{ij} arose from cycles in G' , vertex w cannot be used more than $\frac{1}{2} \deg(w) - 1$ times, i.e.,

$$\sum_{i,j} \lambda_{ij} \cdot \mu_{ij}(w) \leq \frac{1}{2} \deg(w) - 1. \tag{131}$$

This contradicts the equality throughout in (130). ■

10. FURTHER RESULTS ON CURVES ON SURFACES

We finally derive from our results some further properties of curves on compact orientable surfaces. First we note

LEMMA 1. *Let C be a closed curve on the compact orientable surface S such that $\text{mincr}(C, D) = 0$ for each closed curve D . Then C is null-homotopic.*

Proof. Let G be the graph with one vertex and no edges, embedded on S . Then $\text{cr}(G, D) \geq 0 = \text{mincr}(C, D)$ for each closed curve D on S . Hence, by Theorem 3, C is homotopic to a curve in G . So C must be null-homotopic. ■

A second auxiliary result is derived from Theorem 3 (the “homotopic circulation theorem”) and the lemma in Section 9:

LEMMA 2. *Let B and C be primitive closed curves on a compact orientable surface S and $m, n \in \mathbb{N}$ such that $\text{mincr}(B^m, D) = \text{mincr}(C^n, D)$ for each closed curve D . Then $B \sim C$ or $B \sim C^{-1}$, and $m = n$.*

Proof. By symmetry we may assume

$$m^2 \cdot \text{mincr}(B) \leq n^2 \cdot \text{mincr}(C). \tag{132}$$

Moreover, we may assume that $\text{cr}(B) = \text{mincr}(B)$. Consider the graph G made up by B , where the vertex set V of G is exactly the set of points of self-crossings of B . Then for each closed curve D avoiding V ,

$$\begin{aligned} \text{cr}(G, D) &= \text{cr}(B, D) \geq \text{mincr}(B, D) = \frac{1}{m} \text{mincr}(B^m, D) \\ &= \frac{1}{m} \text{mincr}(C^n, D) = \frac{n}{m} \text{mincr}(C, D). \end{aligned} \tag{133}$$

Hence, by Theorem 3, there exist closed curves $C_1, \dots, C_s \sim C$ and $\lambda_1, \dots, \lambda_s > 0$ such that

$$\begin{aligned}
\text{(i)} \quad & \lambda_1 + \dots + \lambda = \frac{n}{m}, \\
\text{(ii)} \quad & \sum_{i=1}^s \lambda_i \chi^{C_i}(e) \leq 1 \text{ for every edge } e \text{ of } G.
\end{aligned} \tag{134}$$

Denote by $\mu_i(v)$ the number of times C_i passes v . Then we derive from the Lemma in Section 9 (using Proposition 11)

$$\begin{aligned}
2 \frac{n^2}{m^2} \cdot \text{mincr}(C) &= \sum_{i=1}^s \lambda_i \sum_{j=1}^s \lambda_j \cdot \text{mincr}(C_i, C_j) \\
&\leq \sum_{i=1}^s \lambda_i \cdot \sum_{v \in V} \mu_i(v) \left(\frac{1}{2} \deg(v) - 1 \right) \\
&= \sum_{v \in V} \left(\frac{1}{2} \deg(v) - 1 \right) \sum_{i=1}^s \mu_i(v) \lambda_i \\
&= \sum_{v \in V} \left(\frac{1}{2} \deg(v) - 1 \right) \frac{1}{2} \sum_{e \in \delta(v)} \sum_{i=1}^s \lambda_i \chi^{C_i}(e) \\
&\leq \sum_{v \in V} \left(\frac{1}{2} \deg(v) - 1 \right) \left(\frac{1}{2} \deg(v) \right) = 2 \text{mincr}(B). \tag{135}
\end{aligned}$$

(Here $\delta(v)$ denotes the set of edges incident to v .) By (132) we have equality throughout in (135). Hence for each i we have equality in (120). By the Lemma, this implies that C_i belongs to the straight decomposition of G . Hence $C_i \sim B$ or $C_i \sim B^{-1}$, implying $B \sim C$ or $B \sim C^{-1}$.

Moreover, by Lemma 1, $\text{mincr}(B, D) > 0$ for at least one closed curve D . So $m = n$ follows from $m \cdot \text{mincr}(B, D) = \text{mincr}(B^m, D) = \text{mincr}(C^n, D) = n \cdot \text{mincr}(C, D) = n \cdot \text{mincr}(B, D)$. ■

We derive the following “unique factorization theorem” for closed curves, generalizing a result of Marden, Richards, and Rodin [12]:

PROPOSITION 14. *For each non-null-homotopic closed curve E on a compact orientable surface S , there exist a primitive closed curve C , unique up to homotopy, and a unique $n \in \mathbb{N}$ such that $E \sim C^n$.*

Proof. We first show that $E \sim C^n$ for at least one primitive closed curve C and $n \in \mathbb{N}$. By Lemma 1, there exists a closed curve D with $\text{mincr}(E, D) > 0$. So if $E \sim C^n$ for some closed curve C and $n \in \mathbb{N}$, then (by Proposition 5)

$$0 < \text{mincr}(E, D) = \text{mincr}(C^n, D) = n \cdot \text{mincr}(C, D), \tag{136}$$

implying that $n \leq \text{mincr}(E, D)$. Hence there exists a largest $n \in \mathbb{N}$ for which there exists a closed curve C with $E \sim C^n$. It follows that C is primitive (otherwise, $C \sim B^m$ for some $m \geq 2$, and hence $E \sim B^{mn}$ with $mn > n$).

Second we show that C and n are unique (up to homotopy). Suppose $C^n \sim B^m$ where C and B are primitive and $m, n \in \mathbb{N}$. In particular, $\text{mincr}(B^m, D) = \text{mincr}(C^n, D)$ for each D . Hence by Lemma 2, $B \sim C$ or $B \sim C^{-1}$, and $m = n$. Suppose $B \sim C^{-1}$. Then C^{2n} is null-homotopic, and hence $\text{mincr}(C, D) = \text{mincr}(C^{2n}, D)/2n = 0$ for each closed curve D . By Lemma 1 this implies that C is null-homotopic, contradicting the primitivity of C . ■

Finally we derive that any curve homotopy class can be identified by the function “mincr” (up to inverting the curve):

PROPOSITION 15. *Let B and C be closed curves on a compact orientable surface S , such that $\text{mincr}(B, D) = \text{mincr}(C, D)$ for each closed curve D . Then $B \sim C$ or $B \sim C^{-1}$.*

Proof. Directly from Lemma 2 and Proposition 14. ■

In [22] we derived from the results of this paper the following extension of Proposition 15:

PROPOSITION 16. *Let C_1, \dots, C_k and C'_1, \dots, C'_k , be primitive closed curves on a compact orientable surface S . Then the following are equivalent:*

- (i) $k = k'$ and there exists a permutation π of $\{1, \dots, k\}$ such that for each $i = 1, \dots, k$, $C'_{\pi(i)}$ is homotopic to C_i or to C_i^{-1} ;
- (ii) for each closed curve D on S ,

$$\sum_{i=1}^k \text{mincr}(C_i, D) = \sum_{i=1}^{k'} \text{mincr}(C'_i, D). \tag{137}$$

Proof. See [22]. ■

ACKNOWLEDGMENTS

I thank Paul Seymour for inspiring discussions, and for carefully reading the text, giving several helpful suggestions improving the presentation, and illuminating some obscurities. I am grateful to Crispin Nash-Williams for asking me whether Theorem 4 above could be true, which led me to the present research. I also thank Stan van Hoesel, Michael Kaufmann, Laci Lovász, Kurt Mehlhorn, and Éva Tardos for stimulating discussions.

REFERENCES

1. L. V. AHLFORS AND L. SARIO, "Riemann Surfaces," Princeton Univ. Press, Princeton, NJ, 1960.
2. R. BAER, Kurventypen auf Flächen, *J. Reine Angew. Math.* **156** (1927), 231–246.
3. H. R. BRAHANA, Systems of circuits on two-dimensional manifolds, *Ann. of Math.* **23** (1921), 144–168.
4. L. E. J. BROUWER, Über eindeutige stetige Transformationen von Flächen in sich, *Math. Ann.* **69** (1910), 176–180.
5. M. DEHN AND P. HEEGAARD, Analysis situs, in "Encyklopädie der mathematischen Wissenschaften, met Einschluss ihrer Anwendungen, III. Band: Geometrie, I. Teil, I. Hälfte" (W. Fr. Meyer and H. Mohrmann, Eds.), pp. 153–220, Teubner, Leipzig, 1907–1910.
6. A. FRANK AND A. SCHRIJVER, Edge-disjoint circuits in graphs on the torus, *J. Combin. Theory Ser. B*, to appear.
7. M. E. GOLDMAN, An algebraic classification of noncompact 2-manifolds, *Trans. Amer. Math. Soc.* **156** (1971), 241–258.
8. C. VAN HOESSEL AND A. SCHRIJVER, Edge-disjoint homotopic paths in a planar graph with one hole, *J. Combin. Theory Ser. B* **48** (1990), 77–91.
9. M. KAUFMANN AND K. MEHLHORN, On local routing of two-terminal nodes, *J. Combin. Theory Ser. B*, to appear.
10. B. VON KERÉKJÁRTÓ, "Vorlesungen über Topologie I: Flächentopologie," Springer-Verlag, Berlin, 1923.
11. S. LINS, A minimax theorem on circuits in projective graphs, *J. Combin. Theory Ser. B* **30** (1981), 253–262.
12. A. MARDEN, I. RICHARDS, AND B. RODIN, On the regions bounded by homotopic curves, *Pacific J. Math.* **16** (1966) 337–339.
13. W. S. MASSEY, "Algebraic Topology: An Introduction," Springer-Verlag, New York, 1967.
14. E. E. MOISE, "Geometric Topology in Dimensions 2 and 3," Springer-Verlag, New York, 1977.
15. H. OKAMURA AND P. D. SEYMOUR, Multicommodity flows in planar graphs, *J. Combin. Theory Ser. B* **31** (1981), 75–81.
16. H. POINCARÉ, 5e complément à l'Analysis Situs, *Rend. Circ. Mat. Palermo* **18** (1904), 45–110.
17. T. RADÓ, Über den Begriff der Riemannschen Fläche, *Acta Litt. Sci. Szeged* **2** (1925), 101–121.
18. I. RICHARDS, On the classification of noncompact surfaces, *Trans. Amer. Math. Soc.* **106** (1963), 259–269.
19. A. SCHRIJVER, Theory of Linear and Integer Programming, Wiley, Chichester, 1986.
20. A. SCHRIJVER, Edge-disjoint cycles of given homotopy type, to appear.
21. A. SCHRIJVER, Edge-disjoint homotopic paths in straight-line planar graphs, *SIAM J. Discrete Math.*, to appear.
22. A. SCHRIJVER, Homotopy and crossings of systems of curves on a surface, *Linear Algebra Appl.* **114** (1989), 157–167.
23. A. SCHRIJVER, On the uniqueness of kernels, *J. Combin. Theory Ser. B*, to appear.
24. A. SCHRIJVER, Disjoint circuits of prescribed homotopies in a graph on a compact surface, *J. Combin. Theory Ser. B*, to appear.
25. H. SEIFERT AND W. THRELFALL, "Lehrbuch der Topologie," Teubner, Leipzig, 1934 (English translation: "A textbook of Topology," Academic Press, New York, 1980).